



XBee/XBee-PRO S1 802.15.4 (Legacy)

RF Modules

User Guide

Revision history—9000982

Revision	Date	Description
S	February 2015	Updated European restrictions for transmitting below 10 dBm. Updated the warranty and certification information. Updated programming examples section. Corrected the maximum value of the IT command. Corrected P1 command parameters.
T	December 2015	Corrected $\overline{\text{RESET}}$ pin information.
U	May 2016	Noted that bit 13 of the SC parameter is not available for XBee-PRO devices. Corrected an error in the I/O line passing parameters table. Added S1 and Legacy to the product name. Updated the certifications.
V	October 2016	Updated and rebranded the documentation.

Trademarks and copyright

Digi, Digi International, and the Digi logo are trademarks or registered trademarks in the United States and other countries worldwide. All other trademarks mentioned in this document are the property of their respective owners.

© 2017 Digi International Inc. All rights reserved.

Disclaimers

Information in this document is subject to change without notice and does not represent a commitment on the part of Digi International. Digi provides this document “as is,” without warranty of any kind, expressed or implied, including, but not limited to, the implied warranties of fitness or merchantability for a particular purpose. Digi may make improvements and/or changes in this manual or in the product(s) and/or the program(s) described in this manual at any time.

Warranty

To view product warranty information, go to the following website:

www.digi.com/howtobuy/terms

Send comments

Documentation feedback: To provide feedback on this document, send your comments to techcomm@digi.com.

Customer support

Digi Technical Support: Digi offers multiple technical support plans and service packages to help our customers get the most out of their Digi product. For information on Technical Support plans and pricing, contact us at +1 952.912.3444 or visit us at www.digi.com/support.

Contents

About the XBee/XBee-PRO S1 802.15.4 (Legacy) RF Modules

Technical specifications	9
XBee/XBee-PRO S1 802.15.4 (Legacy) Performance specifications	10
XBee/XBee-PRO S1 802.15.4 (Legacy) Power requirements	10
General specifications	11
Networking and security specifications	11
Agency approvals	11
XBee/XBee-PRO S1 802.15.4 (Legacy) Antenna options	12
XBee/XBee-PRO S1 802.15.4 (Legacy) Mechanical drawings	12
Mounting considerations	13
Pin signals	14
Design notes	15
Electrical characteristics	17
DC Characteristics (VCC = 2.8 - 3.4 VDC)	18
ADC timing/performance characteristics1	19

Operation

Serial communications	22
UART data flow	22
Transparent operating mode	23
API operating mode	23
Flow control	24
ADC and Digital I/O line support	25
I/O data format	26
API support	26
Sleep support	26
DIO pin change detect	27
Sample rate (interval)	27
I/O line passing	27
Configuration example	28
Networks	28
Peer-to-peer networks	29
NonBeacon (with coordinator)	29
Association	29
Addressing	32
Unicast Mode	32
Broadcast mode	33
Modes of operation	33
Idle mode	34
Transmit/Receive modes	34
Sleep modes	36

Configuration

Programming the RF module	41
Setup	41
Remote configuration commands	42
Send a remote command	42
Apply changes on remote devices	42
Remote command responses	43

AT commands

Special commands	45
WR (Write)	45
RE (Restore Defaults)	45
FR (Software Reset)	45
Networking and security commands	45
CH (Channel)	46
ID (PAN ID)	46
DH (Destination Address High)	46
DL (Destination Address Low)	47
MY (16-bit Source Address)	47
SH (Serial Number High)	47
SL (Serial Number Low)	47
RR (XBee Retries)	48
RN (Random Delay Slots)	48
MM (MAC Mode)	48
NI (Node Identifier)	49
ND (Node Discovery)	49
NT (Node Discover Time)	50
NO (Node Discovery Options)	51
DN (Destination Node)	51
CE (Coordinator Enable)	51
SC (Scan Channels)	52
SD (Scan Duration)	53
A1 (End Device Association)	54
A2 (Coordinator Association)	54
AI (Association Indication)	55
DA (Force Disassociation)	56
FP (Force Poll)	57
AS (Active Scan)	57
ED (Energy Scan)	58
EE (AES Encryption Enable)	58
KY (AES Encryption Key)	59
RF interfacing commands	59
PL (Power Level)	59
CA (CCA Threshold)	60
Sleep commands (low power)	61
SM (Sleep Mode)	61
SO (Sleep Options)	61
ST (Time before Sleep)	62
SP (Cyclic Sleep Period)	62
DP (Disassociated Cyclic Sleep Period)	63
Serial interfacing commands	63
BD (Interface Data Rate)	63

RO (Packetization Timeout)	64
AP (API Enable)	65
NB (Parity)	65
PR (Pull-up/Down Resistor Enable)	65
I/O settings commands	66
D0 (DIO0 Configuration)	66
D1 (DIO1 Configuration)	67
D2 (DIO2 Configuration)	67
D3 (DIO3 Configuration)	68
D4 (DIO4 Configuration)	68
D5 (DIO5 Configuration)	69
D6 (DIO6 Configuration)	69
D7 (DIO7 Configuration)	70
D8 (DIO8 Configuration)	70
IU (I/O Output Enable)	71
IT (Samples before TX)	71
IS (Force Sample)	72
I/O (Digital Output Level)	72
IC (DIO Change Detect)	73
IR (Sample Rate)	73
IA (I/O Input Address)	73
T0 (D0 Output Timeout)	74
T1 (D1 Output Timeout)	74
T2 (D2 Output Timeout)	74
T3 (D3 Output Timeout)	75
T4 (D4 Output Timeout)	75
T5 (D5 Output Timeout)	75
T6 (D6 Output Timeout)	76
T7 (D7 Output Timeout)	76
P0 (PWM0 Configuration)	76
P1 (PWM1 Configuration)	77
M0 (PWM0 Output Level)	77
M1 (PWM1 Output Level)	78
PT (PWM Output Timeout)	78
RP (RSSI PWM Timer)	78
Diagnostic commands	79
VR (Firmware Version)	79
VL (Version Long)	79
HV (Hardware Version)	80
DB (Last Packet RSSI)	80
EC (CCA Failures)	80
EA (ACK Failures)	80
ED (Energy Scan)	81
Command mode options	81
CT (Command Mode Timeout)	81
CN (Exit Command mode)	81
AC (Apply Changes)	82
GT (Guard Times)	82
CC (Command Sequence Character)	82

API operation

API frame specifications	85
API operation (AP parameter = 1)	85
API operation-with escaped characters (AP parameter = 2)	85

Calculate and verify checksums	86
API types	86
Modem Status frame - 0x8A	87
AT Command Frame - 0x08	87
AT Command - Queue Parameter Value frame - 0x09	88
AT Command Response frame - 0x88	89
Remote AT Command Request frame - 0x17	89
Remote Command Response frame - 0x97	90
TX Request: 64-bit address frame - 0x00	91
TX Request: 16-bit address - 0x01	91
TX Status frame - 0x89	92
RX (Receive) packet: 64-bit address frame - 0x80	92
RX (Receive) packet 16-bit address frame - 0x81	93
RX (Receive) Packet: 64-bit address IO frame- 0x82	93
RX Packet: 16-bit address I/O frame - 0x83	94

Certifications

United States (FCC)	97
OEM labeling requirements	97
FCC notices	97
FCC-approved antennas (2.4 GHz)	98
RF exposure	104
Europe	104
OEM labeling requirements	104
Declarations of conformity	105
Antennas	105
Canada (IC)	105
Labeling requirements	105
Japan	105
Labeling requirements	105
ANATEL (Brazil) certification	105

About the XBee/XBee-PRO S1 802.15.4 (Legacy) RF Modules

The XBee and XBee-PRO RF Modules were engineered to meet IEEE 802.15.4 standards and support the unique needs of low-cost, low-power wireless sensor networks. The devices require minimal power and provide reliable delivery of data between devices.

The devices operate within the ISM 2.4 GHz frequency band and are pin-for-pin compatible with each other.

Technical specifications	9
Electrical characteristics	17

Technical specifications

XBee/XBee-PRO S1 802.15.4 (Legacy) Performance specifications

This table describes the performance specifications for the devices.

Specification	XBee	XBee-PRO
Indoor/urban range	Up to 100 ft (30 m)	Up to 300 ft. (90 m) Up to 200 ft (60 m) International variant
Outdoor RF line-of-sight range	Up to 300 ft (90 m)	Up to 1 mile (1600 m) Up to 2500 ft (750 m) international variant
Transmit power output (software selectable)	1 mW (0 dBm)	63 mW (18 dBm)* 10 mW (10 dBm) for international variant
RF data rate	250,000 b/s	250,000 b/s
Serial interface data rate (software selectable)	1200 b/s - 250 kb/s (non-standard baud rates also supported)	1200 bps - 250 kb/s (non-standard baud rates also supported)
Receiver sensitivity (typical)	-92 dBm (1% packet error rate)	100 dBm (1% packet error rate)

XBee/XBee-PRO S1 802.15.4 (Legacy) Power requirements

The following table describes the power requirements for the devices.

Specification	XBee	XBee-PRO
Supply voltage	2.8 - 3.4 V	2.8 - 3.4 V
Transmit current (typical)	45 mA (@ 3.3 V)	<ul style="list-style-type: none"> ■ 250 mA (@3.3 V) (150 mA for international variant) RPSMA module only. ■ 340 mA (@3.3 V) (180 mA for international variant)
Idle/receive current (typical)	50 mA (@ 3.3 V)	55 mA (@ 3.3 V)
Power-down current	< 10 uA	< 10 uA

General specifications

The following table describes the general specifications for the devices.

Specification	XBee	XBee-PRO
Operating frequency band	ISM 2.4 GHz	ISM 2.4 GHz
Dimensions	0.960 in x 1.087 in (2.438 cm x 2.761 cm)	0.960 in x 1.297 in (2.438 cm x 3.294 cm)
Operating temperature	-40 to 85°C (industrial)	-40 to 85°C (industrial)
Antenna options	Integrated whip antenna, embedded PCB antenna, U.FL connector, RPSMA connector	Integrated whip antenna, embedded PCB antenna, U.FL connector, RPSMA connector

Networking and security specifications

The following table describes the networking and security specifications for the devices.

Specification	XBee	XBee-PRO
Supported network topologies	Point-to-point, point-to-multipoint and peer-to-peer	
Number of channels (software selectable)	16 direct sequence channels	12 direct sequence channels
Addressing options	PAN ID, channel and addresses	PAN ID, channel and addresses

Agency approvals

This table describes the agency approvals for the devices.

Specification	XBee	XBee-PRO
United States (FCC Part 15.247)	OUR-XBEE	OUR-XBEEPRO
Industry Canada (IC)	4214A-XBEE	4214A-XBEEPRO
Europe (CE)	Yes	Yes (Maximum 10 dBm transmit power output) ¹

¹See [Certifications](#) or region-specific certification requirements.

Specification	XBee	XBee-PRO
Japan	R201WW07215214	R201WW08215111 (Maximum 10 dBm transmit power output)* Wire, chip, RPMSA, and U.FL versions are certified for Japan. PCB antenna version is not.
Australia/New Zealand	RCM/R-NZ	RCM/R-NZ
Brazil	ANATEL 0369-15-1209	ANATEL 0378-15-1209

XBee/XBee-PRO S1 802.15.4 (Legacy) Antenna options

The ranges specified are typical for the integrated whip (1.5 dBi) and dipole (2.1 dBi) antennas. The printed circuit board (PCB) antenna option provides advantages in its form factor; however, it typically yields shorter range than the whip and dipole antenna options when transmitting outdoors. For more information, see [XBee and XBee-PRO OEM RF Module Antenna Considerations Application Note](#).

XBee/XBee-PRO S1 802.15.4 (Legacy) Mechanical drawings

The following graphics show the mechanical drawings of the XBee / XBee-PRO OEM RF Modules. The XBee and XBee-PRO RF Modules are pin-for-pin compatible.

Note The antenna options not shown.

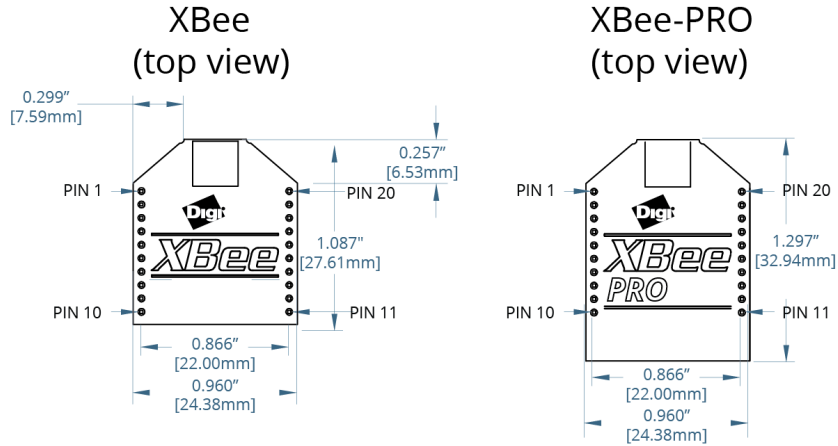

XBee and XBee-PRO (side view)

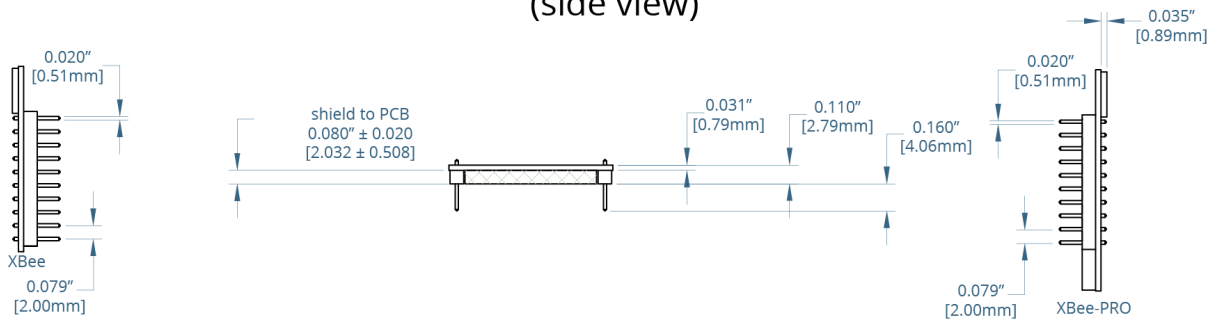

Mounting considerations

We design the through-hole module to mount into a receptacle so that you do not have to solder the module when you mount it to a board. The development kits may contain RS-232 and USB interface boards that use two 20-pin receptacles to receive modules.

The following illustration shows the module mounting into the receptacle on the RS-232 interface board.

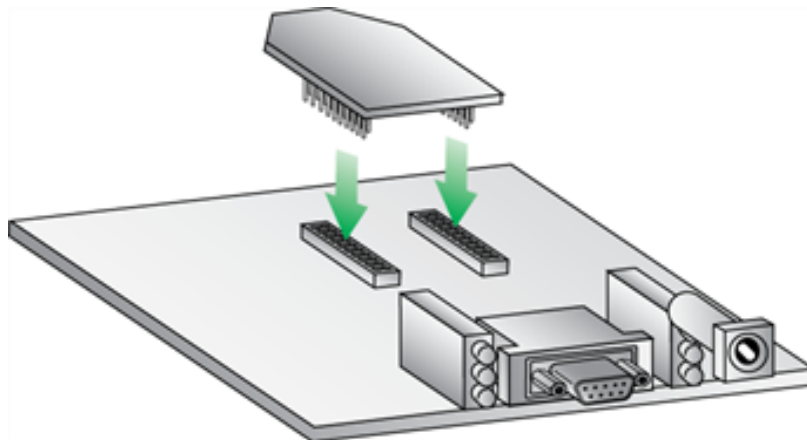

Century Interconnect manufactures the receptacles used on Digi development boards. Several other manufacturers provide comparable mounting solutions; however, Digi currently uses the following receptacles:

- Through-hole single-row receptacles: Samtec part number: MMS-110-01-L-SV (or equivalent)
- Surface-mount double-row receptacles: Century Interconnect part number: CPRMSL20-D-0-1 (or equivalent)
- Surface-mount single-row receptacles: Samtec part number: SMM-110-02-SM-S

Note We recommend that you print an outline of the module on the board to indicate the correct orientation for mounting the module.

Pin signals

The following graphic shows the XBee/XBee-PRO S1 802.15.4 (Legacy) RF Modules pin number for the devices, with the top sides shown; shields are on the bottom:

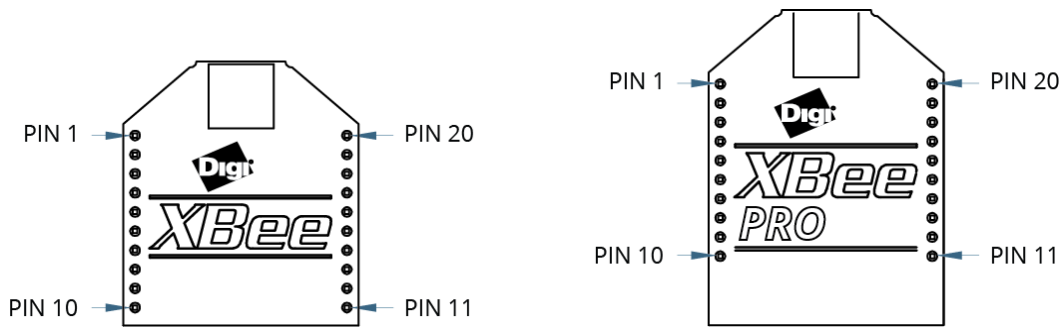

The following table describes the pin assignments for the devices. A horizontal line above the signal name indicates low-asserted signals.

Pin#	Name	Direction	Description
1	VCC	-	Power supply
2	DOUT	Output	UART data out
3	DIN/ <u>CONFIG</u>	Input	UART data In
4	DO8 ¹	Either	Digital output 8
5	<u>RESET</u>	Input/Open drain output	Device reset (reset pulse must be at least 200 ns). This must be driven as an open drain/collector. The device drives this line low when a reset occurs. Never drive this line high.
6	PWM0/RSSI	Either	PWM output 0 / RX signal strength indicator
7	PWM1	Either	PWM output 1

¹Function is not supported at the time of this release.

Pin#	Name	Direction	Description
8	[reserved]	-	Do not connect
9	$\overline{\text{DTR}}/\text{SLEEP_RQ}/\text{DI8}$	Either	Pin sleep control line or digital input 8
10	GND	-	Ground
11	AD4/DIO4	Either	Analog input 4 or digital I/O 4
12	$\overline{\text{CTS}}/\text{DIO7}$	Either	Clear-to-send flow control or digital I/O 7
13	ON/ $\overline{\text{SLEEP}}$	Output	Device status indicator
14	VREF	Input	Voltage reference for A/D inputs
15	Associate/AD5/DIO5	Either	Associated indicator, analog input 5 or digital I/O 5
16	$\overline{\text{RTS}}/\text{DIO6}$	Either	Request-to-send flow control, or digital I/O 6
17	AD3/DIO3	Either	Analog input 3 or digital I/O 3
18	AD2/DIO2	Either	Analog input 2 or digital I/O 2
19	AD1/DIO1	Either	Analog input 1 or digital I/O 1
20	AD0/DIO0	Either	Analog input 0, digital I/O 0

Notes:

- Minimum connections: VCC, GND, DOUT and DIN
- Minimum connections for updating firmware: VCC, GND, DIN, DOUT, RTS and DTR
- Signal direction is specified with respect to the module
- The module includes a 50 k Ω pull-up resistor attached to $\overline{\text{RESET}}$
- You can configure several of the input pull-ups using the PR command
- Leave any unused pins disconnected

Design notes

The XBee modules do not specifically require any external circuitry specific connections for proper operation. However, there are some general design guidelines that we recommend for help in troubleshooting and building a robust design.

Power supply design

A poor power supply can lead to poor device performance, especially if you do not keep the supply voltage within tolerance or if it is excessively noisy. To help reduce noise, place a 1.0 μF and 8.2 pF capacitor as near as possible to pin 1 on the PCB. If you are using a switching regulator for the power supply, switch the frequencies above 500 kHz. Limit the power supply ripple to a maximum 100 mV peak to peak.

Board layout

We design XBee devices to be self sufficient and have minimal sensitivity to nearby processors, crystals or other printed circuit board (PCB) components. Keep power and ground traces thicker than

signal traces and make sure that they are able to comfortably support the maximum current specifications. There are no other special PCB design considerations to integrate XBee devices, with the exception of antennas.

Antenna performance

Antenna location is important for optimal performance. The following suggestions help you achieve optimal antenna performance. Point the antenna up vertically (upright). Antennas radiate and receive the best signal perpendicular to the direction they point, so a vertical antenna's omnidirectional radiation pattern is strongest across the horizon.

Position the antennas away from metal objects whenever possible. Metal objects between the transmitter and receiver can block the radiation path or reduce the transmission distance. Objects that are often overlooked include:

- metal poles
- metal studs
- structure beams
- concrete, which is usually reinforced with metal rods

If you place the device inside a metal enclosure, use an external antenna. Common objects that have metal enclosures include:

- vehicles
- elevators
- ventilation ducts
- refrigerators
- microwave ovens
- batteries
- tall electrolytic capacitors

Do not place XBee devices with the chip or integrated PCB antenna inside a metal enclosure.

Do not place any ground planes or metal objects above or below the antenna.

For the best results, mount the device at the edge of the host PCB. Ensure that the ground, power, and signal planes are vacant immediately below the antenna section.

Pin connection recommendations

The only required pin connections are VCC, GND, DOUT and DIN. To support serial firmware updates, you should connect VCC, GND, DOUT, DIN, RTS, and SLEEP (DTR).

Leave all unused pins disconnected. Pull all inputs on the device high with internal pull-up resistors using the **PR** command. You do not need a specific treatment for unused outputs.

Other pins may be connected to external circuitry for convenience of operation including the Associate LED pin (pin 15). The Associate LED flashes differently depending on the state of the device.

If analog sampling is desired, attach the VRef (pin 14) to a voltage reference.

Keepout area

We recommend that you allow a “keepout” area, as shown in the following drawing.

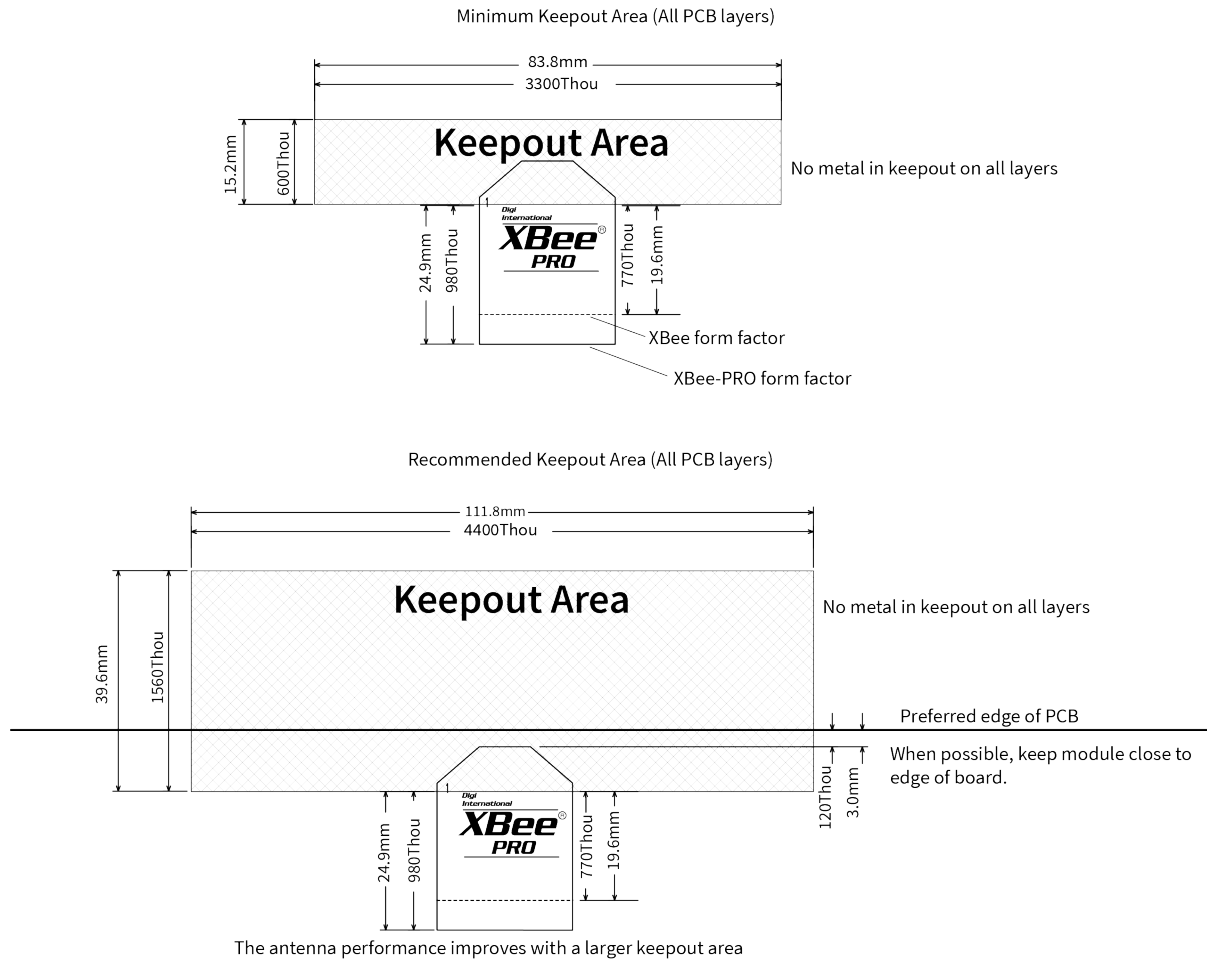

Notes

1. We recommend non-metal enclosures. For metal enclosures, use an external antenna.
2. Keep metal chassis or mounting structures in the keepout area at least 2.54 cm (1 in) from the antenna.
3. Maximize the distance between the antenna and metal objects that might be mounted in the keepout area.
4. These keepout area guidelines do not apply for wire whip antennas or external RF connectors. Wire whip antennas radiate best over the center of a ground plane.

Electrical characteristics

The following tables list the electrical characteristics of the XBee/XBee-PRO XBee/XBee-PRO S1 802.15.4 (Legacy) RF Modules.

DC Characteristics (VCC = 2.8 - 3.4 VDC)

Symbol	Characteristic	Condition	Min	Typical	Max	Unit
V _{IL}	Input low voltage	All Digital Inputs	-	-	0.35 * V _{VCC}	V
V _{IH}	Input high voltage	All Digital Inputs	0.7 * V _{VCC}	-	-	V
V _{OL}	Output low voltage	I _{OL} = 2 mA, V _{VCC} >= 2.7 V	-	-	0.5	V
V _{OH}	Output high voltage	I _{OH} = -2 mA, V _{VCC} >= 2.7 V	V _{VCC} - 0.5	-	-	V
I _{IIN}	Input leakage Current	V _{IN} = V _{VCC} or GND, all inputs, per pin	-	0.025	1	μA
I _{IOZ}	High impedance leakage current	V _{IN} = V _{VCC} or GND, all I/O High-Z, per pin	-	0.025	1	μA
TX	Transmit current	V _{VCC} = 3.3 V	-	45 (XBee) 215, 140 (XBee-PRO, International)	-	mA
RX	Receive current	V _{VCC} = 3.3 V	-	50 (XBee) 55 (XBee-PRO)	-	mA
PWR-DWN	Power-down current	SM parameter = 1	-	<10	-	μA

ADC characteristics (operating)

Symbol	Characteristic	Condition	Min	Typical	Max	Unit
V _{REFH}	V _{REF} - analog-to-digital converter reference range		2.08	-	V _{DDAD} ¹	V
I _{REF}	V _{REF} - reference supply current	Enabled	-	200	-	μA
		Disabled or Sleep Mode	-	<0.01	0.02	μA
V _{INDC}	Analog input voltage ²		V _{SSAD} - 0.3		V _{DDAD} + 0.3	V

1. V_{DDAD} is connected to V_{VCC}.
2. Maximum electrical operating range, not valid conversion range.

ADC timing/performance characteristics¹

Symbol	Characteristic	Condition	Min	Typical	Max	Unit
R _{AS}	Source impedance at input ²	-		-	-	kΩ
V _{AIN}	Analog input voltage ³	-	V _{REFL}	-	V _{REFL}	V
RES	Ideal resolution (1 LSB) ⁴	2.08V < VDDAD < 3.6V	2.031	-	3.516	mV
DNL	Differential non-linearity ⁵	-	-	±0.5	±1.0	LSB
INL	Integral non-linearity ⁶	-	-	±0.5	±1.0	LSB
E _{ZS}	Zero-scale error ⁷	-	-	±0.4	±1.0	LSB
F _{FS}	Full-scale error ⁸	-	-	±0.4	±1.0	LSB
E _{IL}	Input leakage error ⁹	-	-	±0.05	±5.0	LSB
E _{TU}	Total unadjusted error ¹⁰	-	-	±1.1	±2.5	LSB

- All accuracy numbers are based on the processor and system being in WAIT state (very little activity and no I/O switching) and that adequate low-pass filtering is present on analog input pins (filter with 0.01 μF to 0.1 μF capacitor between analog input and VREFL). Failure to observe these guidelines may result in system or microcontroller noise causing accuracy errors which will vary based on board layout and the type and magnitude of the activity. Data transmission and reception during data conversion may cause some degradation of these specifications, depending on the number and timing of packets. We advise testing the ADCs in your installation if best accuracy is required.
- R_{AS} is the real portion of the impedance of the network driving the analog input pin. Values greater than this amount may not fully charge the input circuitry of the ATD resulting in accuracy error.
- Analog input must be between V_{REFL} and V_{REFH} for valid conversion. Values greater than V_{REFH} will convert to \$3FF.
- The resolution is the ideal step size or 1LSB = (V_{REFH}-V_{REFL})/1024.
- Differential non-linearity is the difference between the current code width and the ideal code width (1LSB). The current code width is the difference in the transition voltages to and from the current code.
- Integral non-linearity is the difference between the transition voltage to the current code and the adjusted ideal transition voltage for the current code. The adjusted ideal transition voltage is (Current Code-1/2)*(1/((VREFH+EFS)-(VREFL+EZS))).
- Zero-scale error is the difference between the transition to the first valid code and the ideal transition to that code. The Ideal transition voltage to a given code is (Code-1/2)*(1/(VREFH-VREFL)).

8. Full-scale error is the difference between the transition to the last valid code and the ideal transition to that code. The ideal transition voltage to a given code is $(\text{Code}-1/2) * (1/(\text{VREFH}-\text{VREFL}))$.
9. Input leakage error is error due to input leakage across the real portion of the impedance of the network driving the analog pin. Reducing the impedance of the network reduces this error.
10. Total unadjusted error is the difference between the transition voltage to the current code and the ideal straight-line transfer function. This measure of error includes inherent quantization error (1/2LSB) and circuit error (differential, integral, zero-scale, and full-scale) error. The specified value of ETU assumes zero EIL (no leakage or zero real source impedance).

Operation



WARNING! When operating at 1 W power output, observe a minimum separation distance of 6 ft (2 m) between devices. Transmitting in close proximity of other devices can damage the device's front end.

Serial communications	22
ADC and Digital I/O line support	25
Networks	28
Addressing	32
Modes of operation	33

Serial communications

RF Modules interface to a host device through a serial port. Using its serial port, the device communicates with any of the following:

- Logic and voltage compatible UART
- Level translator to any serial device (for example, through an RS-232 or USB interface board)

UART data flow

Devices that have a UART interface connect directly to the pins of the XBee/XBee-PRO S1 802.15.4 (Legacy) as shown in the following figure. The figure shows system data flow in a UART-interfaced environment. Low-asserted signals have a horizontal line over the signal name.

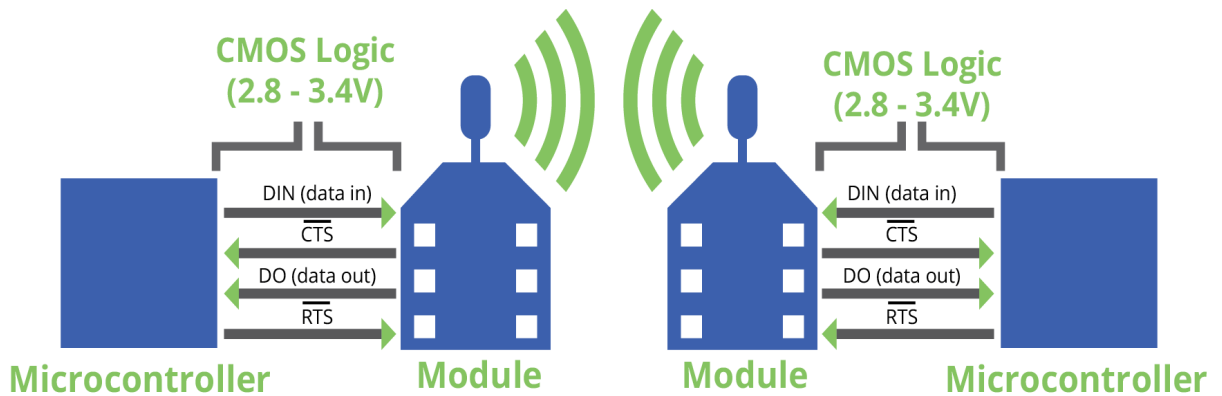

Serial data

A device sends data to the XBee/XBee-PRO S1 802.15.4 (Legacy)'s UART through pin 3 (DIN) as an asynchronous serial signal. When the device is not transmitting data, the signal idles high.

For serial communication to occur, you must configure the UART of both devices (the microcontroller and the XBee/XBee-PRO S1 802.15.4 (Legacy)) with compatible settings for the baud rate, parity, start bits, stop bits, and data bits.

Each data byte consists of a start bit (low), 8 data bits (least significant bit first) and a stop bit (high). The following diagram illustrates the serial bit pattern of data passing through the device. The diagram shows UART data packet 0x1F (decimal number 31) as transmitted through the device.

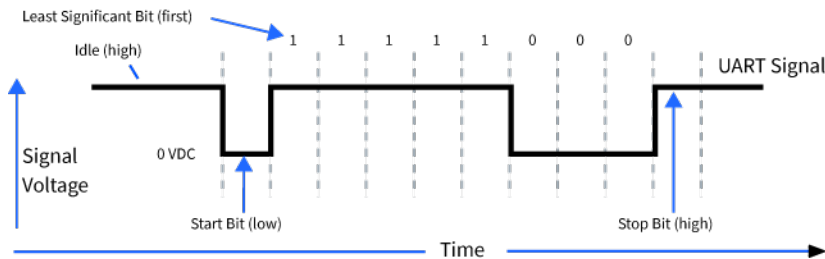

Serial communications depend on the two UARTs (the microcontroller and the RF device) to be configured with compatible settings, including baud rate, parity, start bits, stop bits, and data bits.

The UART baud rate and parity settings on the XBee module can be configured with the BD and NB commands, respectively. For more information, see [AT commands](#).

Transparent operating mode

Devices operate in this mode by default. The device acts as a serial line replacement when it is in Transparent operating mode. The device queues all UART data it receives through the DIN pin for RF transmission. When a device receives RF data, it sends the data out through the DOUT pin. You can set the configuration parameters using Command mode.

Serial-to-RF packetization

The device buffers data in the serial receive buffer until one of the following causes the data to be packetized and transmitted:

- The device receives no serial characters for the amount of time determined by the **RO** (Packetization Timeout) parameter. If **RO** = 0, packetization begins when a character is received.
- The device receives the Command Mode Sequence (**GT + CC + GT**). Any character buffered in the serial receive buffer before the sequence is transmitted.
- The device receives the maximum number of characters that fits in an RF packet (100 bytes).

If the device cannot immediately transmit (for example, if it is already receiving RF data), it stores the serial data in the DI buffer. The device packetizes the data and sends the data at any **RO** timeout or when it receives the maximum packet size (100 bytes).

If the DI buffer becomes full, hardware or software flow control must be implemented in order to prevent overflow (that is, loss of data between the host and module).

API operating mode

API (Application Programming Interface) operating mode is an alternative to the default Transparent operating mode. The frame-based API extends the level to which a host application can interact with the networking capabilities of the module.

When in API mode, all data entering and leaving the device is contained in frames that define operations or events within the module.

Transmit data frames (received through the DI pin (pin 3)) include:

- RF Transmit data frame
- Command frame (equivalent to AT commands)

Receive Data frames (sent out the DO pin (pin 2)) include:

- RF-received data frame
- Command response
- Event notifications such as reset, associate, disassociate, and so on

The API provides alternative means of configuring modules and routing data at the host application layer. A host application sends data frames to the device that contains address and payload information instead of using command mode to modify addresses. The device sends data frames to the application containing status packets, as well as source, RSSI, and payload information from received data packets.

The API operation option facilitates many operations such as the following examples:

- Transmitting data to multiple destinations without entering Command Mode
- Receiving success/failure status of each transmitted RF packet
- Identifying the source address of each received packet

To implement API operation, see [API operation](#).

Flow control

The XBee/XBee-PRO S1 802.15.4 (Legacy) maintains buffers to collect serial and RF data that it receives. The serial receive buffer collects incoming serial characters and holds them until the device can process them. The serial transmit buffer collects the data it receives via the RF link until it transmits that data out the serial port. The following figure shows the process of device buffers collecting received serial data.

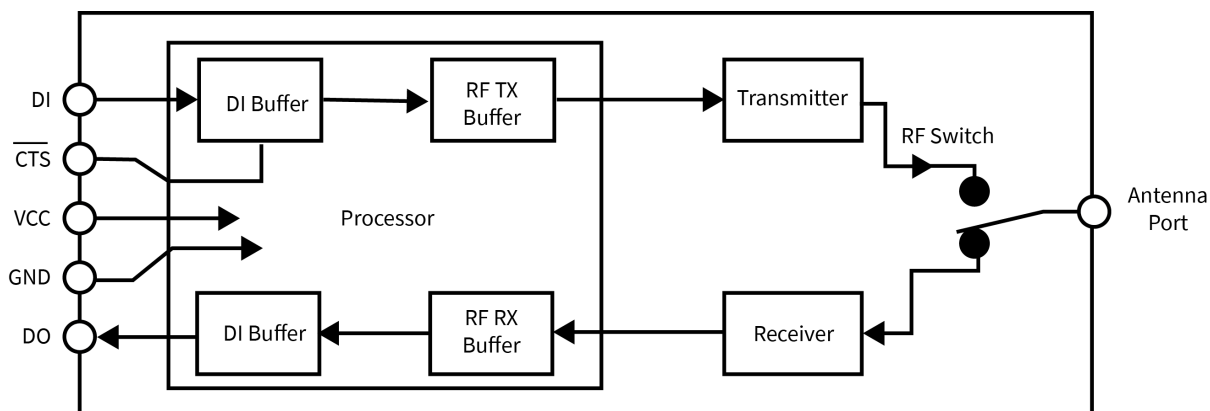

DI (Data in) buffer

When serial data enters the RF module through the DI pin (pin 3), the device stores data in the DI buffer until it can be processed.

Hardware Flow Control (CTS)

If you enable $\overline{\text{CTS}}$ flow control (by setting **D7** to 1), when the DI buffer is 17 bytes away from being full, the device de-asserts CTS (sets it high) to signal to the host device to stop sending serial data. The device reasserts CTS after the serial receive buffer has 34 bytes of space.

To eliminate the need for flow control:

1. Send messages that are smaller than the DI buffer size (202 bytes).
2. Interface at a lower baud rate [BD (Interface Data Rate) parameter] than the throughput data rate.

Example where the DI buffer may become full and possibly overflow:

If the device is receiving a continuous stream of RF data, it places any serial data that arrives on the DI pin in the DI buffer. The device transmits data in the DI buffer over-the-air when it is no longer receiving RF data in the network.

For more information, see the following command descriptions:

- [RO \(Packetization Timeout\)](#)
- [BD \(Interface Data Rate\)](#)
- [D7 \(DIO7 Configuration\)](#)

DO (Data out) buffer

When RF data is received, the data enters the DO buffer and is sent out the serial port to a host device. Once the DO Buffer reaches capacity, any additional incoming RF data is lost.

Hardware Flow Control ($\overline{\text{RTS}}$)

If you enable $\overline{\text{RTS}}$ flow control ([D6 \(DIO6 Configuration\)](#) Parameter = 1), the device does not send data out the DO buffer as long as RTS (pin 16) is de-asserted.

Examples where the DO buffer may become full, resulting in dropped RF packets:

1. If the RF data rate is set higher than the interface data rate of the device, the device may receive data faster than it can send the data to the host. Even occasional transmissions from a large number of devices can quickly accumulate and overflow the transmit buffer.
2. If the host does not allow the device to transmit data out from the serial transmit buffer due to being held off by hardware flow control.

See the [D6 \(DIO6 Configuration\)](#) command description for more information.

ADC and Digital I/O line support

The XBee/XBee-PRO RF Modules support ADC (analog-to-digital conversion) and digital I/O line passing. The following pins support multiple functions:

- Pin functions and their associated pin numbers and commands
- AD = Analog-to-Digital Converter, DIO = Digital Input/Output

Note Pin functions in parentheses are not applicable to this section.

Pin function	Pin#	AT Command
AD0/DIO0	20	D0
AD1/DIO1	19	D1
AD2/DIO2	18	D2
AD3/DIO3 / (COORD_SEL)	1	D3
AD4/DIO4	11	D4
AD5/DIO5 / (ASSOCIATE)	15	D5
DIO6/(RTS)	16	D6
DIO7/(CTS)	12	D7
DIO8/(DTR) / (Sleep_RQ)	9	D8

Use the following setting to enable ADC and DIO pin functions:

Support type	Setting
ADC support	ATDn = 2
Digital input support	ATDn = 3
Digital output low support	ATDn = 4
Digital output high support	ATDn = 5

I/O data format

I/O data begins with a header. The first byte of the header defines the number of samples forthcoming. The last two bytes of the header (Channel Indicator) define which inputs are active. Each bit represents either a DIO line or ADC channel. The following figure illustrates the bits in the header.

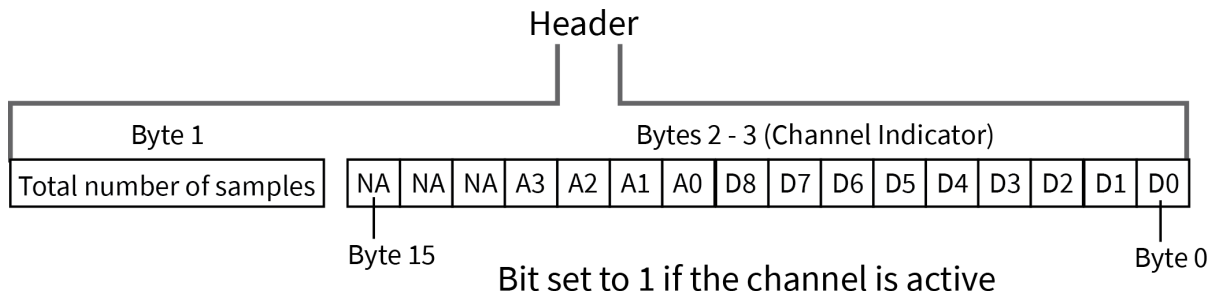

Sample data follows the header and the channel indicator frame determines how to read the sample data. If any of the DIO lines are enabled, the first two bytes are the DIO sample. The ADC data follows. ADC channel data is represented as an unsigned 10-bit value right-justified on a 16-bit boundary. The following figure illustrates the sample data bits.

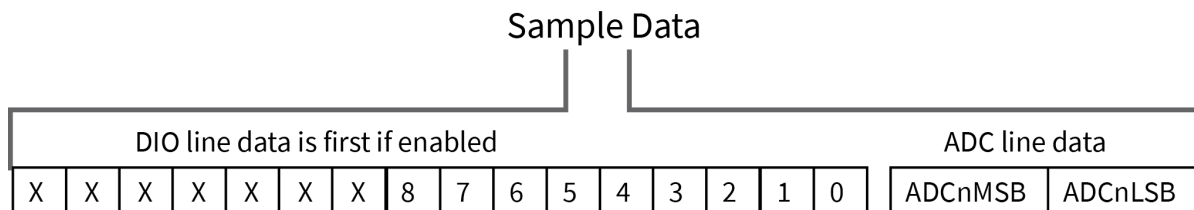

API support

I/O data is sent out the UART using an API frame. All other data can be sent and received using Transparent Operation or API frames if API mode is enabled (**AP** > 0).

API Operations support two RX (Receive) frame identifiers for I/O data (set 16-bit address to 0xFFFE and the device does 64-bit addressing):

- 0x82 for RX Packet: 64-bit Address I/O
- 0x83 for RX Packet: 16-bit Address I/O

The API command header is the same as shown in [RX Packet: 64-bit Address frame 0x80](#) and [RX Packet: 16-bit address I/O frame - 0x83](#). RX data follows the format described in [I/O data format](#).

Sleep support

Automatic wake-up sampling can be suppressed by setting **SO** bit 1. When a device wakes, it always performs a sample based on any active ADC or DIO lines. This allows sampling based on the sleep cycle whether it be Cyclic Sleep (**SM** parameter = 4 or 5) or Pin Sleep (**SM** = 1). To gather more samples when awake, set the **IR** (Sample Rate) parameter.

For Cyclic Sleep modes: If the **IR** parameter is set, the device stays awake until the **IT** (Samples before TX) parameter is met. The device stays awake for **ST** (Time before Sleep) time.

DIO pin change detect

When you use the **IC** (DIO Change Detect) command to enable DIO Change Detect, DIO lines 0-7 are monitored. When a change is detected on a DIO line, the following occurs:

1. An RF packet is sent with the updated DIO pin levels. This packet does not contain any ADC samples.
2. Any queued samples are transmitted before the change detect data. This may result in receiving a packet with less than **IT** (Samples before TX) samples.

Note Change detect does not affect Pin Sleep wake-up. The D8 pin (DTR/Sleep_RQ/DI8) is the only line that wakes a device from Pin Sleep. If not all samples are collected, the device still enters Sleep Mode after a change detect packet is sent. Change detect is only supported when the **Dx** (DIOx Configuration) parameter equals 3, 4 or 5.

Applicable Commands: **IC** (DIO Change Detect), **IT** (Samples before TX)

Note Change detect is only supported when the **Dx** (DIOx Configuration) parameter equals 3, 4 or 5.

Sample rate (interval)

The Sample Rate (Interval) feature allows enabled ADC and DIO pins to be read periodically on devices that are not configured to operate in Sleep Mode. When one of the Sleep Modes is enabled and the **IR** (Sample Rate) parameter is set, the device stays awake until **IT** (Samples before TX) samples have been collected.

Once a particular pin is enabled, the appropriate sample rate must be chosen. The maximum sample rate that can be achieved while using one A/D line is 1 sample/ms or 1 kHz. The device cannot keep up with transmission when **IR** and **IT** are equal to 1 and we do not recommend configuring the device to sample at rates greater than once every 20 ms.

I/O line passing

You can set up virtual wires between XBee/XBee-PRO Modules. When a device receives an RF data packet that contains I/O data, it can be setup to update any enabled outputs (PWM and DIO) based on the data it receives.

I/O lines are mapped in pairs. For example, AD0 can only update PWM0 and DI5 can only update DO5. The default setup is for outputs not to be updated, which results in the I/O data being sent out the UART (See the [IU \(I/O Output Enable\)](#) command). To enable the outputs for updating, set the **IA** (I/O Input Address) parameter with the address of the device that has the appropriate inputs enabled. This binds the outputs to a particular device's input. This does not affect the ability of the device to receive I/O line data from other modules; it affects only its ability to update enabled outputs. The **IA** parameter can also be set up to accept I/O data for output changes from any module by setting the **IA** parameter to 0xFFFF.

When outputs are changed from their non-active state, the device can be setup to return the output level to its non-active state. Set the timers using the **Tn** (**Dn** Output Timer) and **PT** (PWM Output Timeout) commands. The timers are reset every time the device receives a valid I/O sample packet with a matching **IA** address.

You can adjust the **IC** (Change Detect) and **IR** (Sample Rate) parameters to keep the outputs set to their active output if the system needs more time than the timers can handle.

Note DI8 cannot be used for I/O line passing.

Applicable commands:

- **IA** (I/O Input Address)
- **TN** (Dn Output Timeout)
- **P0** (PWM0 Configuration)
- **P1** (PWM1 Configuration)
- **M0** (PWM0 Output Level)
- **M1** (PWM1 Output Level)
- **PT** (PWM Output Timeout)
- **RP** (RSSSI PWM Timer)

Configuration example

The following table provides an example of a pair of RF devices for a simple A/D link:

Remote Configuration	Base Configuration
DL = 0x1234	DL = 0x5678
MY = 0x5678	MY = 0x1234
D0 = 2	P0 = 2
D1 = 2	P1 = 2
IR = 0x14	IU = 1
IT = 5	IA = 0x5678 (or 0xFFFF)

These settings configure the remote device to sample AD0 and AD1 once each every 20 ms. It then buffers 5 samples each before sending them back to the base device. The base then receives a 32-byte transmission (20 bytes data and 12 bytes framing) every 100 ms.

Networks

The following table describes some common terms we use when discussing networks.

Term	Definition
Association	Establishing membership between end devices and a coordinator.
Coordinator	A full-function device (FFD) that provides network synchronization by polling nodes.
End device	When in the same network as a coordinator. Devices that rely on a coordinator for synchronization and can be put into states of sleep for low-power applications.
PAN	Personal Area Network. A data communication network that includes one or more end devices and optionally a coordinator.

Peer-to-peer networks

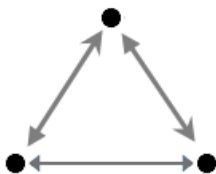

By default, XBee/XBee-PRO S1 802.15.4 (Legacy) modules are configured to operate within a peer-to-peer network topology and therefore are not dependent upon master/slave relationships. This means that devices remain synchronized without the use of master/server configurations and each device in the network shares both roles of master and slave. Our peer-to-peer architecture features fast synchronization times and fast cold start times. This default configuration accommodates a wide range of RF data applications.

You can establish a peer-to-peer network by configuring each module to operate as an End Device (**CE** = 0), disabling End Device Association on all modules (**A1** = 0) and setting **ID** and **CH** parameters to be identical across the network.

NonBeacon (with coordinator)

You can configure a device as a Coordinator by setting the **CE** (Coordinator Enable) parameter to 1. Use the **A2** (Coordinator Association) parameter to power up the Coordinator .

In a Coordinator system, you configure the Coordinator to use direct or indirect transmissions. If the **SP** (Cyclic Sleep Period) parameter is set to 0, the Coordinator sends data immediately. Otherwise, the **SP** parameter determines the length of time the Coordinator retains the data before discarding it. In general, **SP** (Cyclic Sleep Period) and **ST** (Time before Sleep) parameters should be set to match the **SP** and **ST** settings of the End Devices.

Association

Association is the establishment of membership between End Devices and a Coordinator. Establishing membership is useful in scenarios that require a central unit (Coordinator) to relay messages to or gather data from several remote units (End Devices), assign channels, or assign PAN IDs.

An RF data network that consists of one Coordinator and one or more End Devices forms a PAN (Personal Area Network). Each device in a PAN has a PAN Identifier (**ID** (PAN ID) parameter), which must be unique to prevent miscommunication between PANs. Set the Coordinator PAN ID using the **ID** (PAN ID) and **A2** (Coordinator Association) commands.

An End Device can associate to a Coordinator without knowing the address, PAN ID, or channel of the Coordinator. The **A1** (End Device Association) parameter bit fields determine the flexibility of an End Device during association. Use the **A1** parameter for an End Device to dynamically set its destination address, PAN ID, and/or channel.

For example, if the PAN ID of a Coordinator is known, but the operating channel is not, set the **A1** command on the End Device to enable the 'Auto_Associate' and 'Reassign_Channel' bits. Additionally, set the **ID** parameter to match the PAN ID of the associated Coordinator.

Coordinator / End Device setup and operation

To configure a module to operate as a Coordinator, set the **CE** (Coordinator Enable) parameter to '1'. Set the **CE** parameter of End Devices to '0' (default). Coordinator and End Devices should contain matching firmware versions.

NonBeacon (with Coordinator) systems

You can configure the Coordinator to use direct or indirect transmissions. If the **SP** (Cyclic Sleep Period) parameter is set to '0', the Coordinator sends data immediately. Otherwise, the **SP** parameter determines the length of time the Coordinator retains the data before discarding it. In general, **SP** (Cyclic Sleep Period) and **ST** (Time before Sleep) parameters should be set to match the **SP** and **ST** settings of the End Devices.

Coordinator start-up

The **A2** (Coordinator Association) command governs coordinator power-up. On power-up, the Coordinator undergoes the following sequence of events:

1. Check A2 parameter- Reassign_PANID flag

Set (bit 0 = 1)

The Coordinator issues an Active Scan. The Active Scan selects one channel and transmits a request to the broadcast address (0xFFFF) and broadcast PAN ID (0xFFFF). The Coordinator then listens on that channel for beacons from any Coordinator operating on that channel. The **SD** (Scan Duration) parameter value determines the listen time on each channel.

Once the time expires on that channel, the Active Scan selects another channel and again transmits the BeaconRequest as before. This process continues until all channels have been scanned, or until 5 PANs have been discovered. When the Active Scan is complete, the results include a list of PAN IDs and Channels being used by other PANs. This list is used to assign a unique PAN ID to the new Coordinator. The ID parameter will be retained if it is not found in the Active Scan results. Otherwise, the ID (PAN ID) parameter setting will be updated to a PAN ID that was not detected.

Not set (bit 0 = 0)

The Coordinator retains its ID setting. No Active Scan is performed.

2. Check A2 parameter - Reassign_Channel flag (bit 1)

Set (bit 1 = 1)

The Coordinator issues an Energy Scan. The Energy Scan selects one channel and scans for energy on that channel. The **SD** (Scan Duration) parameter specifies the duration of the scan. Once the scan is completed on a channel, the Energy Scan selects the next channel and begins a new scan on that channel. This process continues until all channels have been scanned.

When the Energy Scan is complete, the results include the maximal energy values detected on each channel. This list is used to determine a channel where the least energy was detected. If an Active Scan was performed (Reassign_PANID Flag set), the channels used by the detected PANs are eliminated as possible channels. The device uses the results of the Energy Scan and the Active Scan (if performed) to find the best channel (that is, the channel with the least energy that is not used by any detected PAN). Once the device selects the best channel, the **CH** (Channel) parameter value is updated to that channel.

Not set (bit 1 = 0)

The Coordinator retains its **CH** setting, and an Energy Scan is not performed.

3. Start Coordinator

The Coordinator starts on the specified channel (**CH** parameter) and PAN ID (**ID** parameter).

Note These may be selected in steps 1 or 2.

The Coordinator only allows End Devices to associate to it if the **A2** parameter “AllowAssociation” flag is set. Once the Coordinator has successfully started, the Associate LED blinks 1 time per second. If the Coordinator has not started, the LED is solid.

4. Modify coordinator

Once a Coordinator has started, modifying the **A2** (Reassign_Channel or Reassign_PANID bits), **ID**, **CH** or **MY** parameters causes the Coordinator’s MAC to reset. The Coordinator RF module (including volatile RAM) is not reset.

Changing the **A2** AllowAssociation bit does not reset the Coordinator’s MAC. In a non-beaconing system, End Devices that associated to the Coordinator prior to a MAC reset have knowledge of the new settings on the Coordinator. If the Coordinator were to change its **ID**, **CH** or **MY** settings, the End Devices would no longer be able to communicate with the non-beacon Coordinator. Do not change the **ID**, **CH**, **MY**, or **A2** (Reassign_Channel or Reassign_PANID bits) once a Coordinator has started.

End device start-up

The **A1** (End Device Association) command governs End Device power-up. On power-up, the End Device undergoes the following sequence of events:

1. Check A1 parameter - AutoAssociate Bit

Set (bit 2 = 1)

The End Device attempts to associate to a Coordinator. See [2. Discover Coordinator \(if Auto-Associate Bit Set\)](#) and [3. Associate to a valid coordinator](#).

Not set (bit 2 = 0)

The End Device does not attempt to associate to a Coordinator. The End Device operates as specified by its **ID**, **CH** and **MY** parameters. Association is considered complete and the Associate LED blinks quickly (5 times per second).

2. Discover Coordinator (if Auto-Associate Bit Set)

The end device issues an Active Scan. The Active Scan selects one channel and transmits a BeaconRequest command to the broadcast address (0xFFFF) and broadcast PAN ID (0xFFFF). The Active Scan then listens on that channel for beacons from any Coordinator operating on that channel. The **SD** parameter determines the listen time on each channel.

Once the time expires on that channel, the Active Scan selects another channel and again transmits the BeaconRequest command as before. This process continues until all channels have been scanned, or until 5 PANs have been discovered. When the Active Scan is complete, the results include a list of PAN IDs and Channels that are being used by detected PANs.

The end device selects a coordinator to associate with according to the **A1** parameter “Reassign_PANID” and “Reassign_Channel” flags:

- **Reassign_PANID bit set (bit 0 = 1)** - End device can associate with a PAN with any **ID** value.
- **Reassign_PANID bit not set (bit 0 = 0)** - End device only associates with a PAN whose **ID** setting matches the **ID** setting of the End Device.
- **Reassign_Channel bit set (bit 1 = 1)** - End device can associate with a PAN with any **CH** value.
- **Reassign_Channel bit not set (bit 1 = 0)** - End device will only associate with a PAN whose **CH** setting matches the **CH** setting of the end device.

After applying these filters to the discovered coordinators, if multiple candidate PANs exist, the end device selects the PAN whose transmission link quality is the strongest. If no valid coordinator is found, the end device either goes to sleep (as dictated by its **SM** (Sleep Mode) parameter) or retry Association.

Note An end device also disqualifies coordinators if they are not allowing association (**A2** - AllowAssociation bit), or, if the coordinator is not using the same NonBeacon scheme as the end device. They must both be programmed with NonBeacon code.

3. Associate to a valid coordinator

Once the device finds a valid coordinator ([2. Discover Coordinator \(if Auto-Associate Bit Set\)](#)), the end device sends an AssociationRequest message to the coordinator. The end device then waits for an AssociationConfirmation from the coordinator. Once it receives the Confirmation, the end device is Associated and the Associate LED blinks rapidly (two times per second). If the end device has not associated, the LED is solid.

4. End Device changes once an End Device has associated

Changing **A1**, **ID** or **CH** parameters causes the End Device to disassociate and restart the Association procedure.

If the End Device fails to associate, the **AI** command indicates the failure.

Addressing

Every RF data packet sent over-the-air contains a Source Address and Destination Address field in its header. The XBee/XBee-PRO S1 802.15.4 (Legacy) conforms to the 802.15.4 specification and supports both short 16-bit addresses and long 64-bit addresses. A unique 64-bit IEEE source address is assigned at the factory and can be read with the **SL** (Serial Number Low) and **SH** (Serial Number High) commands. You must manually configure short addressing. A device uses its unique 64-bit address as its Source Address if its **MY** (16-bit Source Address) value is 0xFFFF or 0xFFFE.

- To send a packet to a specific device using 64-bit addressing, set the Destination Address (**DL** + **DH**) of the sender to match the Source Address (**SL** + **SH**) of the intended destination device.
- To send a packet to a specific **module** using 16-bit addressing, set **DL** (Destination Address Low) parameter to equal the **MY** parameter of the intended destination module and set the **DH** (Destination Address High) parameter to '0.'

Unicast Mode

By default, the RF device operates in Unicast Mode. Unicast Mode is the only mode that supports retries. While in this mode, receiving devices send an ACK (acknowledgment) of RF packet reception to the transmitter. If the transmitting device does not receive the ACK, it re-sends the packet up to three times or until it receives the ACK.

Short 16-bit addresses

You can configure the device to use short 16-bit addresses as the Source Address by setting (**MY** < 0xFFFE). Setting the **DH** parameter (**DH** = 0) configures the Destination Address to be a short 16-bit address (if **DL** < 0xFFFE). For two devices to communicate using short addressing, the Destination Address of the transmitter device must match the **MY** parameter of the receiver.

The following table shows a sample network configuration that enables Unicast Mode communications using short 16-bit addresses.

Parameter	RF Module 1	RF Module 2
MY (Source Address)	0x01	0x02
DH (Destination Address High)	0	0
DL (Destination Address Low)	0x02	0x01

Long 64-bit addresses

You can use The RF device’s serial number (**SL** parameter concatenated to the **SH** parameter) as a 64-bit source address when the **MY** (16-bit Source Address) parameter is disabled. When you disable the **MY** parameter (MY = 0xFFFF or 0xFFFE), the device’s source address is set to the 64-bit IEEE address stored in the **SH** and **SL** parameters.

When an End Device associates to a Coordinator, its **MY** parameter is set to 0xFFFE to enable 64-bit addressing. The 64-bit address of the device is stored as **SH** and **SL** parameters. To send a packet to a specific device, the Destination Address (**DL + DH**) on the sender must match the Source Address (**SL + SH**) of the receiver.

Broadcast mode

Any RF device within range accepts a packet that contains a broadcast address. When configured to operate in Broadcast Mode, receiving devices do not send ACKs (acknowledgments) and transmitting devices do not automatically re-send packets as is the case in Unicast Mode.

To send a broadcast packet to all devices regardless of 16-bit or 64-bit addressing, set the destination addresses of all the devices as shown below.

Sample Network Configuration (All modules in the network):

- **DL** (Destination Low Address) = 0x0000FFFF

If **RR** is set to 0, only one packet is broadcast. If **RR** > 0, (RR + 2) packets are sent in each broadcast. No acknowledgments are returned. For more information, see [RR \(XBee Retries\)](#).

- **DH** (Destination High Address) = 0x00000000 (default value)

When you are programming the device, enter the parameters in hexadecimal notation (without the “0x” prefix). Leading zeros may be omitted.

Modes of operation

This section describes the different operating modes for the device.

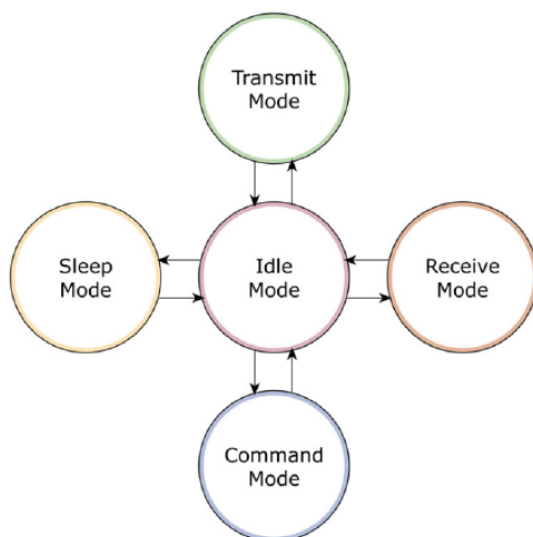

Idle mode

When not receiving or transmitting data, the device is in Idle mode.

The device shifts into the other modes of operation under the following conditions:

- Transmit mode (serial data is received in the DI buffer)
- Receive mode (valid RF data received through the antenna)
- Sleep mode (Sleep mode condition is met)
- Command mode (Command mode sequence issued)

Transmit/Receive modes

This section provides information about the different types of transmit and receive modes.

RF data packets

Each transmitted data packet contains a Source Address and Destination Address field. The Source Address matches the address of the transmitting device as specified by the **MY** (Source Address) parameter (if **MY** \geq 0xFFFE), the **SH** (Serial Number High) parameter or the **SL** (Serial Number Low) parameter. The <Destination Address> field is created from the **DH** (Destination Address High) and **DL** (Destination Address Low) parameter values. The Source Address and/or Destination Address fields either contain a 16-bit short or long 64-bit long address.

The RF data packet structure follows the 802.15.4 specification. For more information, see [Addressing](#).

Direct and indirect transmission

There are two methods to transmit data:

- Direct transmission: data is transmitted immediately to the Destination Address
- Indirect transmission: a packet is retained for a period of time and is only transmitted after the destination device (source address = destination address) requests the data.

Indirect transmissions can only occur on a Coordinator. Thus, if all nodes in a network are End Devices, only direct transmissions occurs. Indirect transmissions are useful to ensure packet delivery to a sleeping node. The Coordinator currently is able to retain up to two indirect messages.

Direct transmission

A Coordinator can be configured to use only direct transmission by setting the **SP** (Cyclic Sleep Period) parameter to 0. Also, a Coordinator using indirect transmissions reverts to direct transmission if it knows the destination device is awake.

To enable this behavior, the **ST** (Time before Sleep) value of the Coordinator must be set to match the **ST** value of the End Device. Once the End Device either transmits data to the Coordinator or polls the Coordinator for data, the Coordinator uses direct transmission for all subsequent data transmissions to that device address until **ST** time occurs with no activity (at which point it reverts to using indirect transmissions for that device address). "No activity" means no transmission or reception of messages with a specific address. Broadcast messages do not reset the **ST** timer.

Indirect transmission

To configure Indirect Transmissions in a Personal Area Network (PAN), the **SP** (Cyclic Sleep Period) parameter value on the Coordinator must be set to match the longest sleep value of any End Device. The sleep period value on the Coordinator determines how long (time or number of beacons) the Coordinator retains an indirect message before discarding it.

An End Device must poll the Coordinator once it wakes from Sleep to determine if the Coordinator has an indirect message for it. For Cyclic Sleep Modes, this is done automatically every time the device wakes (after **SP** time). For Pin Sleep Modes, the **A1** (End Device Association) parameter value must be set to enable Coordinator polling on pin wake-up. Alternatively, an End Device can use the **FP** (Force Poll) command to poll the Coordinator as needed.

Clear Channel Assessment (CCA)

Prior to transmitting a packet, the device performs a CCA (Clear Channel Assessment) on the channel to determine if the channel is available for transmission. The detected energy on the channel is compared with the **CA** (Clear Channel Assessment) parameter value. If the detected energy exceeds the **CA** parameter value, the device does not transmit the packet.

Also, the device inserts a delay before a transmission takes place. You can set this delay using the **RN** (Backoff Exponent) parameter. If you set **RN** to 0, then there is no delay before the first CCA is performed. The **RN** parameter value is the equivalent of the "minBE" parameter in the 802.15.4 specification. The transmit sequence follows the 802.15.4 specification.

By default, the **MM** (MAC Mode) parameter = 0. On a CCA failure, the device attempts to re-send the packet up to two additional times.

When in Unicast packets with **RR** (Retries) = 0, the device executes two CCA retries. Broadcast packets always get two CCA retries.

Note Customers in Europe who have the XBee 802.15.4 module must manage their CCA settings. See [CA \(CCA Threshold\)](#) for **CA** values.

Acknowledgment

If the transmission is not a broadcast message, the device expects to receive an acknowledgment from the destination node. If an acknowledgment is not received, the packet is resent up to three more times. If the acknowledgment is not received after all transmissions, an ACK failure is recorded.

Sleep modes

Sleep modes enable the device to enter states of low-power consumption when not in use. In order to enter Sleep Mode, one of the following conditions must be met (in addition to the device having a non-zero **SM** parameter value):

- SLEEP_RQ is asserted and the device is in a pin sleep mode (**SM** = 1, 2, or 5)
- The device is idle (no data transmission or reception) for the amount of time defined by the **ST** (Time before Sleep) parameter.

Note **ST** is only active when **SM** = 4 or 5.

The following table shows the sleep mode configurations.

Sleep mode setting	Transition into sleep mode	Transition out of sleep mode (wake)	Characteristics	Related commands	Power consumption
Pin hibernate SM 1	Assert (high) Sleep_RQ (pin 9)	De-assert (low) Sleep_RQ	Pin/Host-controlled/NonBeacon systems only/Lowest Power	(SM)	< 10 μ A (@3.0 VCC)
Pin doze SM 2	Assert (high) Sleep_RQ (pin 9)	De-assert (low) Sleep_RQ	Pin/Host-controlled/NonBeacon systems only/Fastest wake-up	(SM)	< 50 μ A
Cyclic Sleep SM 4	Automatic transition to Sleep Mode as defined by the SM (Sleep Mode) and ST (Time before Sleep) parameters	Transition occurs after the cyclic sleep time interval elapses. The time interval is defined by the SP (Cyclic Sleep Period) parameter.	RF module wakes in pre-determined time intervals to detect if RF data is present/When SM = 5	(SM), SP, ST	< 50 μ A when sleeping

Sleep mode setting	Transition into sleep mode	Transition out of sleep mode (wake)	Characteristics	Related commands	Power consumption
Cyclic Sleep SM 5	Automatic transition to Sleep Mode as defined by the SM (Sleep Mode) and ST (Time before Sleep) parameters or on a falling edge transition of the SLEEP_RQ pin	Transition occurs after the cyclic sleep time interval elapses. The time interval is defined by the SP (Cyclic Sleep Period) parameter.	RF module wakes in pre-determined time intervals to detect if RF data is present. Module also wakes on a falling edge of SLEEP_RQ.	(SM), SP, ST	< 50 μ A when sleeping

The **SM** command is central to setting Sleep Mode configurations. By default, Sleep Modes are disabled (**SM** = 0) and the device remains in Idle/Receive Mode. When in this state, the device is constantly ready to respond to serial or RF activity.

Pin/Host-controlled sleep modes

The transient current when waking from pin sleep (**SM** = 1 or 2) does not exceed the idle current of the module. The current ramps up exponentially to its idle current.

Pin hibernate (**SM=1**)

- Pin/Host-controlled
- Typical power-down current: < 10 μ A (@3.0 VCC)
- Typical wake-up time: 10.2 ms

Pin Hibernate Mode minimizes quiescent power (power consumed when in a state of rest or inactivity). This mode is voltage level-activated. When the device asserts Sleep_RQ (pin 9), it finishes any transmit, receive or association activities, enters Idle Mode, and then enters a state of sleep. The device does not respond to either serial or RF activity while in pin sleep.

To wake a sleeping device operating in Pin Hibernate Mode, de-assert Sleep_RQ (pin 9). The device wakes when Sleep_RQ is de-asserted and is ready to transmit or receive when the CTS line is low. When waking the device, the pin must be de-asserted at least two 'byte times' after CTS goes low. This assures that there is time for the data to enter the DI buffer.

Pin doze (**SM = 2**)

- Pin/Host-controlled
- Typical power-down current: < 50 μ A
- Typical wake-up time: 2.6 ms

Pin doze mode functions the same as Pin hibernate mode. However, Pin doze features faster wake-up time and higher power consumption.

To wake a sleeping device operating in Pin Doze Mode, de-assert Sleep_RQ (pin 9). The device wakes when Sleep_RQ is de-asserted and is ready to transmit or receive when the CTS line is low. When

waking the device, the pin must be de-asserted at least two 'byte times' after CTS goes low. This assures that there is time for the data to enter the DI buffer.

Cyclic sleep modes

This section provides information on the different types of cyclic sleep modes.

Cyclic Sleep Remote (SM = 4)

- Typical Power-down Current: < 50 μ A (when asleep)
- Typical wake-up time: 2.6 ms

The Cyclic Sleep modes allow devices to periodically check for RF data. When the **SM** parameter is set to 4, the XBee/XBee-PRO S1 802.15.4 (Legacy) is configured to sleep, then wakes once per cycle to check for data from a device configured as a Cyclic Sleep Coordinator (**SM** = 0, **CE** = 1). The Cyclic Sleep Remote sends a poll request to the coordinator at a specific interval set by the **SP** (Cyclic Sleep Period) parameter. The coordinator transmits any queued data addressed to that specific remote upon receiving the poll request.

If no data is queued for the remote, the coordinator does not transmit and the remote returns to sleep for another cycle. If the device transmits queued data back to the remote, it stays awake to allow for back and forth communication until the **ST** (Time before Sleep) timer expires.

If configured, **CTS** goes low each time the remote wakes, allowing for communication initiated by the remote host if desired.

Cyclic Sleep Remote with Pin Wake-up (SM = 5)

Use this mode to wake a sleeping remote device through either the RF interface or by de-asserting **SLEEP_RQ** for event-driven communications. The cyclic sleep mode works as described previously with the addition of a pin-controlled wake-up at the remote device. The **Sleep_RQ** pin is edge-triggered, not level-triggered. The device wakes when a low is detected then set **CTS** low as soon as it is ready to transmit or receive.

Any activity resets the **ST** (Time before Sleep) timer, so the device goes back to sleep only after there is no activity for the duration of the timer. Once the device wakes (pin-controlled), it ignores further pin activity. The device transitions back into sleep according to the **ST** time regardless of the state of the pin.

Cyclic Sleep Coordinator (SM = 6)

- Typical current = Receive current
- Always awake

Note The **SM=6** parameter value exists solely for backwards compatibility with firmware version 1.x60. If backwards compatibility with the older firmware version is not required, always use the **CE** (Coordinator Enable) command to configure a device as a Coordinator.

This mode configures a device to wake cyclic sleeping remotes through RF interfacing. The Coordinator accepts a message addressed to a specific remote 16 or 64-bit address and holds it in a buffer until the remote wakes and sends a poll request. Messages not sent directly (buffered and requested) are called "Indirect messages". The Coordinator only queues one indirect message at a time. The Coordinator holds the indirect message for a period 2.5 times the sleeping period indicated by the **SP** (Cyclic Sleep Period) parameter. Set the Coordinator's **SP** parameter to match the value used by the remotes.

Command mode

Command mode is a state in which the firmware interprets incoming characters as commands. The XBee/XBee-PRO S1 802.15.4 (Legacy) supports two Command mode options: [AT commands](#) and [API operation](#).

AT Command Mode

This section provides information about entering, sending, and exiting Command Mode.

Enter Command mode

Send the three-character command sequence **+++** and observe guard times before and after the command characters.

Default AT Command Mode Sequence (for transition to Command Mode):

- No characters sent for one second [**GT** (Guard Times) parameter = 0x3E8]
- Input three plus characters (“+++”) within one second [**CC** (Command Sequence Character) parameter = 0x2B]
- No characters sent for one second [**GT** (Guard Times) parameter = 0x3E8]

You can modify all parameter values in the sequence to reflect user preferences.

Failure to enter AT Command Mode is most commonly due to a baud rate mismatch. Ensure the **Baud** setting on the **PC Settings** tab matches the interface data rate of the RF module. By default, the **BD** (Baud Rate) parameter = 3 (9600 b/s).

Send AT commands

Once the device enters Command mode, use the syntax in the following figure to send AT commands. Every AT command starts with the letters **AT**, which stands for "attention." The **AT** is followed by two characters that indicate which command is being issued, then by some optional configuration values. To read a parameter value stored in the device's register, omit the parameter field.



The preceding example changes the device's destination address (Low) to 0x1F.

To store the new value to non-volatile (long term) memory, send the **WR** (Write) command. This allows parameter values that you modify to persist in the device's registry after a reset. Otherwise, the device restores parameters to the previous values after a reset.

Response to AT commands

Exit Command mode

1. Send the **CN** (Exit Command Mode) command followed by a carriage return.
or:
2. If the device does not receive any valid AT commands within the time specified by **CT** (Command Mode Timeout), it returns to Idle Mode.

For an example of programming the device using AT Commands and descriptions of each configurable parameter, see [AT commands](#).

Configuration

Programming the RF module	41
Remote configuration commands	42

Programming the RF module

This section provides examples on how to program an RF module using AT Command Mode.

For more information about using AT Command Mode, see [AT commands](#).

For information regarding module programming using API Mode, see [API operation](#).

Setup

The programming examples in this section require the installation of XCTU and a serial connection to a PC. We stock RS-232 and USB boards to facilitate interfacing with a PC. For more information about XCTU installation and setup, see the [XCTU User Guide](#).

1. Download XCTU from the [Digi website](#).
2. After you have downloaded the .exe file to your PC, double-click the file to launch the XCTU Setup Wizard. Follow the steps in the wizard to completely install XCTU.
3. Mount the RF module to an interface board, and then connect the module assembly to a PC.
4. Launch XCTU and click the **Add devices** tab in the upper left corner of the screen.
5. Verify that the baud and parity settings of the Com Port match those of the RF module.

The screenshot shows a configuration window with the following settings:

- Baud Rate: 9600
- Data Bits: 8
- Parity: None
- Stop Bits: 1
- Flow Control: None
- The radio module is programmable.

Note Failure to enter AT Command Mode is typically due to baud rate mismatch. Ensure that the **Baud** setting on the **Add radio device** window matches the interface data rate of the RF module. By default, the BD parameter = 9600 b/s.

Sample configuration: modify RF Module destination address

Using the Interface

Example: Once you have added the module to XCTU, complete the following steps:

1. Click on the module in the Radio Modules area to display the Configuration working mode. This mode shows most of the module's parameters that you can edit.
2. Scroll down on the right panel until you find the parameter you want to edit, in this case the **DL** (Destination Address Low) parameter, or use the search box and type "DL". XCTU automatically scrolls to the selected parameter.
3. Change the value of the parameter to, for example, **1A0D**. If you have not saved the parameter, a green triangle appears in the lower right corner of the parameter.

i DL Destination Address	1A0D
--------------------------	------

- Click the write button to save the value to non-volatile memory.

If you change other parameters but have not saved them, you can use the **Write radio settings** button  to save the change.

Sample configuration: restore RF Module defaults

Example: Use the Configuration working mode tab in XCTU to restore the default parameter values.

- After establishing a connection between the module and a PC, click the Configuration working mode button.

- Click the **Load default firmware** settings button and agree to restore the default values. 

The restored parameters appear with a green triangle appears in the lower right corner of the parameter, meaning they have been changed but not saved.

If you have not saved the parameter, a green triangle appears in the lower right corner of the parameter.

All the parameters surrounding box must change to grey color indicating that their values are now saved in the non-volatile memory of the module.

- Click the **Write module settings**  button to save all of the parameters.

All the parameters must change to grey indicating that their values are now saved in the non-volatile memory of the module.

Remote configuration commands

The API firmware has provisions to send configuration commands to remote devices using the Remote Command Request API frame (see [API operation](#)). Use the API frame to send commands to a remote device to read or set command parameters.

Send a remote command

To send a remote command populate the Remote AT Command Request frame (0x17) with Values for the 64 bit and 16 bit addresses. If you want to set up 64-bit addressing, populate the 16-bit address field with 0xFFFE. If you use any other value in the 16-bit address field, the device uses the 16-bit address and ignores the 64-bit address.

If you want to receive a command response, set the Frame ID to a non-zero value. Only unicasts of remote commands are supported.

Apply changes on remote devices

When you use remote commands to change command parameter settings on a remote device, parameter changes do not take effect until you apply the changes. For example, changing the **BD** parameter does not change the serial interface on the remote until the changes are applied. To apply changes, do one of the following:

- Set the apply changes option bit in the API frame.
- Issue an **AC** (Apply Changes) command to the remote device.
- Issue a **WR + FR** command to the remote device to save changes and reset the device.

Remote command responses

If the remote device receives a remote command request transmission, and the API frame ID is non-zero, the remote sends a remote command response transmission back to the device that sent the remote command. When a remote command response transmission is received, a device sends a remote command response API frame out its UART. The remote command response indicates the status of the command (success, or reason for failure), and in the case of a command query, it includes the register value. The device that sends a remote command will not receive a remote command response frame if either of the following conditions exist:

- The destination device could not be reached.
- The frame ID in the remote command request is set to 0.

AT commands

XBee/XBee-PRO RF Modules expect numerical values in hexadecimal. Hexadecimal values are designated by a “0x” prefix, and decimal equivalents are designated by a “d” suffix. Commands are contained within the following command categories:

Note All modules within a PAN should operate using the same firmware version.

Special commands	45
Networking and security commands	45
RF interfacing commands	59
Sleep commands (low power)	61
Serial interfacing commands	63
I/O settings commands	66
Diagnostic commands	79
Command mode options	81

Special commands

The following commands are special commands.

WR (Write)

Writes parameter values to non-volatile memory so that parameter modifications persist through subsequent resets.

If you make changes without writing them to non-volatile memory, the device reverts back to previously saved parameters the next time the device is powered-on.

Note Once you issue a **WR** command, do not send any additional characters to the device until after you receive the **OK** response.

Parameter range

N/A

Default

N/A

RE (Restore Defaults)

Restore device parameters to factory defaults.

The **RE** command does not write restored values to non-volatile (persistent) memory. Issue the **WR** (Write) command after issuing the **RE** command to save restored parameter values to non-volatile memory.

Parameter range

N/A

Default

N/A

FR (Software Reset)

Forces a software reset on the device. The reset simulates powering off and then on again the device. The device responds immediately with an **OK** and performs a reset 100 ms later.

Parameter range

N/A

Default

N/A

Note Minimum firmware version required: 1.x80. Firmware versions are numbered in hexadecimal notation.

Networking and security commands

The following AT commands are networking and security commands.

CH (Channel)

Set or read the operating channel devices used to transmit and receive data. The channel is one of three addressing configurations available to the device. The other configurations are the PAN ID (**ID** command) and destination addresses (**DL** and **DH** commands).

In order for devices to communicate with each other, they must share the same channel number. A network can use different channels to prevent devices in one network from listening to the transmissions of another. Adjacent channel rejection is 23 dB.

The command uses 802.15.4 channel numbers. Center frequency = 2405 MHz + (**CH** - 11 decimal) * 5 MHz.

Parameter range

0xB - 0x1A (XBee)

0x0C - 0x17 (XBee-PRO)

Default

0xC (12 decimal)

ID (PAN ID)

Set or read the Personal Area Network (PAN) ID. Use **0xFFFF** to broadcast messages to all PANs. Devices must have the same network identifier to communicate with each other. Unique PAN IDs enable control of which RF packets a device receives.

Setting the **ID** parameter to **0xFFFF** indicates a global transmission for all PANs. It does not indicate a global receive.

Parameter range

0 - 0xFFFF

Default

0x3332 (13106 decimal)

DH (Destination Address High)

Set or read the upper 32 bits of the 64-bit destination address. When you combine **DH** with **DL**, it defines the 64-bit destination address that the device uses for data transmission.

A device only communicates with other devices having the same channel (**CH** parameter), PAN ID (**ID** parameter) and destination address (**DH** + **DL** parameters).

To transmit using a 16-bit address, set **DH** parameter to zero and **DL** less than 0xFFFF. The broadcast address for the PAN is 0x000000000000FFFF.

For more information, see [Addressing](#).

Parameter range

0 - 0xFFFFFFFF

Default

0

DL (Destination Address Low)

Set or read the upper 32 bits of the 64-bit destination address. When you combine **DH** with **DL**, it defines the 64-bit destination address that the device uses for data transmission.

A device only communicates with other devices having the same channel (**CH** parameter), PAN ID (**ID** parameter) and destination address (**DH** + **DL** parameters).

To transmit using a 16-bit address, set **DH** parameter to zero and **DL** less than 0xFFFF. The broadcast address for the PAN is 0x000000000000FFFF.

For more information, see [Addressing](#).

Parameter range

0 - 0xFFFFFFFF

Default

0

MY (16-bit Source Address)

Sets or reads the device's 16-bit source address. Set **MY** = 0xFFFF to disable reception of packets with 16-bit addresses. The 64-bit source address (serial number) and broadcast address (0x000000000000FFFF) are always enabled.

Parameter range

0 - 0xFFFF

Default

0

SH (Serial Number High)

Displays the upper 32 bits of the unique IEEE 64-bit extended address assigned to the XBee. The 64-bit source address is always enabled. This value is read-only and it never changes.

Parameter range

0 - 0xFFFFFFFF [read-only]

Default

Set in the factory

SL (Serial Number Low)

Displays the lower 32 bits of the unique IEEE 64-bit RF extended address assigned to the XBee. The 64-bit source address is always enabled. This value is read-only and it never changes.

Parameter range

0 - 0xFFFFFFFF [read-only]

Default

Set in the factory

RR (XBee Retries)

Set or reads the maximum number of retries the device executes in addition to the three retries provided by the 802.15.4 MAC. For each device retry, the 802.15.4 MAC can execute up to three retries.

The following applies for broadcast messages: If **RR** = **0**, only one packet is broadcast. If **RR** is > **0**, **RR** + 2 packets are sent on each broadcast. No acknowledgments are returned on a broadcast.

This value does not need to be set on all devices for retries to work. If retries are enabled, the transmitting device sets a bit in the Digi RF Packet header that requests the receiving device to send an ACK. If the transmitting device does not receive an ACK within 200 ms, it re-sends the packet within a random period up to 48 ms. Each device retry can potentially result in the MAC sending the packet four times (one try plus three retries). Retries are not attempted for indirect messages that are purged.

Note Minimum firmware version required: 1.xA0. Firmware versions are numbered in hexadecimal notation.

Parameter range

0 - 6

Default

0

RN (Random Delay Slots)

Sets or reads the minimum value of the back-off exponent in the CSMA-CA algorithm. The Carrier Sense Multiple Access - Collision Avoidance (CSMA-CA) algorithm was engineered for collision avoidance.

If **RN** = **0**, collision avoidance is disabled during the first iteration of the algorithm (802.15.4 - macMinBE).

Unlike CSMA-CD, which reacts to network transmissions after collisions have been detected, CSMA-CA acts to prevent data collisions before they occur. As soon as a device receives a packet that is to be transmitted, it checks if the channel is clear (no other device is transmitting). If the channel is clear, the packet is sent over-the-air. If the channel is not clear, the device waits for a randomly selected period of time, then checks again to see if the channel is clear. After a time, the process ends and the data is lost.

Parameter range

0 - 3 (exponent)

Default

0

MM (MAC Mode)

The **MM** command is used to set and read the MAC Mode value. The **MM** command disables/enables the use of a Digi header contained in the 802.15.4 RF packet. By default (**MM** = 0), Digi Mode is enabled and the module adds an extra header to the data portion of the 802.15.4 packet. This enables the following features:

- **ND** and **DN** command support
- Duplicate packet detection when using ACKs

- **RR** command
- DIO/AIO sampling support

The **MM** command allows users to turn off the use of the extra header. Modes 1 and 2 are strict 802.15.4 modes. If the Digi header is disabled, the features above are also disabled.

When **MM** = 1 or 3, MAC retries are not supported.

When the Digi header is disabled, encrypted data that is not valid will be sent out of the UART and not filtered out.

Note Minimum firmware version required: 1.x80. Firmware versions are numbered in hexadecimal notation.

Parameter range

0 - 3

Parameter	Configuration
0	Digi Mode (802.15.4 + Digi header)
1	802.15.4 (no ACKs)
2	802.15.4 (with ACKs)
3	Digi Mode (no ACKs)

Default

0

NI (Node Identifier)

Stores the node identifier string for a device, which is a user-defined name or description of the device. This can be up to 20 ASCII characters.

- The command automatically ends when the maximum bytes for the string have been entered.

Use the **ND** (Network Discovery) command with this string as an argument to easily identify devices on the network.

The **DN** command also uses this identifier.

Note Minimum firmware version required: 1.x80. Firmware versions are numbered in hexadecimal notation.

Parameter range

A string of case-sensitive ASCII printable characters from 0 to 20 bytes in length. The string cannot start with the space character. A carriage return or a comma automatically ends the command.

Default

N/A

ND (Node Discovery)

Discovers and reports all of the devices found on its current operating channel (CH parameter) and PAN ID (ID parameter). The **ND** command also accepts a Node Identifier as a parameter. In this case,

only a module matching the supplied identifier responds.

The **ND** command uses a 64-bit long address when sending and responding to an **ND** request. The module transmits a globally addressed **ND** command packet. The NT (Node Discover Time) parameter determines the amount of time allowed for responses.

In AT Command mode, a carriage return (0x0D) designates a command completion. Since two carriage returns end a command response, the application receives three carriage returns at the end of the command. If the device receives no responses, the application only receives one carriage return. When in API mode, the application receives a frame (with no data) and status (set to **OK**) at the end of the command.

When the **ND** command packet is received, the remote sets up a random time delay (up to 2.2 sec) before replying as follows:

Node discover response (AT command mode format - Transparent operation):

MY<CR>

SH<CR>

SL<CR>

DB<CR>

NI<CR>

<CR> (This is part of the response and not the end of command indicator.)

Node discover response (API format - data is binary, except with the NI command):

2 bytes for **MY** (Source Address) value

4 bytes for **SH** (Serial Number High) value

4 bytes for **SL** (Serial Number Low) value

1 byte for **DB** (Received Signal Strength) value

NULL-terminated string for **NI** (Node Identifier) value (max 20 bytes without NULL terminator)

Note Minimum firmware version required: 1.x80. Firmware versions are numbered in hexadecimal notation.

Parameter range

Optional 20-character **NI** value

Default

N/A

NT (Node Discover Time)

Sets the amount of time a base node waits for responses from other nodes when using the **ND** (Node Discover) command. The **NT** value is transmitted with the **ND** command.

Remote nodes set up a random hold-off time based on this time. Once the **ND** command has ended, the base discards any response it receives.

Note Minimum firmware version required: 1.xA0. Firmware versions are numbered in hexadecimal notation.

Parameter range

0x1 - 0xFC (x 100 ms)

Default

0x19 (2.5 decimal seconds)

NO (Node Discovery Options)

Enables node discover self-response on the device.

Use **NO** to suppress or include a self-response to **ND** (Node Discover) commands. When **NO** bit 1 = 1, a device performing a Node Discover includes a response entry for itself.

Note Minimum firmware version required: 1.xC5. Firmware versions are numbered in hexadecimal notation.

Parameter range

0 - 1

Default

0x0

DN (Destination Node)

Resolves an **NI** (Node identifier) string to a physical address (case sensitive).

The following events occur after **DN** discovers the destination node:

1. The device sets **DL** and **DH** to the extended (64-bit) address of the device with the matching **NI** string.
2. The receiving device returns OK (or ERROR).
3. The device automatically exits Command mode.

If there is no response from a module within 200 milliseconds or you do not specify a parameter (by leaving it blank), the command terminates and returns an ERROR message.

Note Minimum firmware version required: 1.x80. Firmware versions are numbered in hexadecimal notation.

Parameter range

20-byte ASCII string

Default

N/A

CE (Coordinator Enable)

Sets or reads the coordinator setting.

Note Minimum firmware version required: 1.x80. Firmware versions are numbered in hexadecimal notation.

Parameter range

0 - 1

Parameter	Description
0	End Device
1	Coordinator

Default

0

SC (Scan Channels)

Sets or reads the list of channels to scan for all Active and Energy Scans as a bit field. This affects scans initiated in the **AS** (Active Scan) and **ED** (Energy Scan) commands in Command mode and during End Device Association and Coordinator startup.

Note Minimum firmware version required: 1.x80. Firmware versions are numbered in hexadecimal notation.

Parameter range

0 - 0xFFFF (bit field)

Bit field mask:

Bit	Parameter
0	0x0B (not available on XBee-PRO)
1	0x0C
2	0x0D
3	0x0E
4	0x0F
5	0x10
6	0x11
7	0x12
8	0x13
9	0x14
10	0x15
11	0x16
12	0x17
13	0x18 (not available on XBee-PRO)
14	0x19 (not available on XBee-PRO)
15	0x1A (not available on XBee-PRO)

Default

0x1FFE (all XBee-PRO Channels)

SD (Scan Duration)

Sets or reads the scan duration exponent.

Coordinator: If you set the **ReassignPANID** option on the coordinator (refer to [A2 \(Coordinator Association\)](#)), **SD** determines the length of time the coordinator scans channels to locate existing PANs. If you set the **ReassignChannel** option, **SD** determines how long the coordinator performs an Energy Scan to determine which channel it will operate on.

End Device: Duration of Active Scan during Association. In a Beacon system, set **SD=BE** of the coordinator. **SD** must be set at least to the highest **BE** parameter of any Beaconsing Coordinator with which an end device or coordinator wants to discover.

Note Minimum firmware version required: 1.x80. Firmware versions are numbered in hexadecimal notation.

Scan Time is measured as:

$$([\# \text{ of channels to scan}] * (2 \wedge \text{SD}) * 15.36 \text{ ms}) + (38 \text{ ms} * [\# \text{ of channels to scan}]) + 20 \text{ ms}$$

Use the **SC** (Scan Channels) command to set the number of channels to scan. The XBee can scan up to 16 channels (**SC** = 0xFFFF). The XBee-PRO can scan up to 13 channels (**SC**= 0x1FFE).

Example

The following table shows the results for a thirteen channel scan.

SD setting	Time
0	0.18 s
2	0.74 s
4	2.95 s
6	11.80 s
8	47.19 s
10	3.15 min
12	12.58 min
14	50.33 min

Parameter range

0 - 0x0F (exponent)

Default

4

A1 (End Device Association)

Sets or reads the End Device association options.

Note Minimum firmware version required: 1.x80. Firmware versions are numbered in hexadecimal notation.

Parameter range

0 - 0x0F (bit field)

Bit field:

Bit	Meaning	Setting	Description
0	ReassignPanID	0	Only associates with Coordinator operating on PAN ID that matches device ID.
		1	May associate with Coordinator operating on any PAN ID.
1	ReassignChannel	0	Only associates with Coordinator operating on matching CH channel setting.
		1	May associate with Coordinator operating on any channel.
2	Auto Associate	0	Device will not attempt association.
		1	Device attempts association until success. Note This bit is only for Non-Beacon systems. End Devices in Beacon-enabled system must always associate to a Coordinator.
3	PollCoordOnPinWake	0	Pin Wake does not poll the Coordinator for indirect (pending) data.
		1	Pin Wake sends Poll Request to Coordinator to extract any pending data.
4 - 7	Reserved		

Default

0

A2 (Coordinator Association)

Sets or reads the Coordinator association options.

Note Minimum firmware version required: 1.x80. Firmware versions are numbered in hexadecimal notation.

Parameter range

0 - 7 (bit field)

Bit field:

Bit	Meaning	Setting	Description
0	ReassignPanID	0	Coordinator will not perform Active Scan to locate available PAN ID. It operates on ID (PAN ID).
		1	Coordinator performs an Active Scan to determine an available ID (PAN ID). If a PAN ID conflict is found, the ID parameter will change.
1	ReassignChannel	0	Coordinator will not perform Energy Scan to determine free channel. It operates on the channel determined by the CH parameter.
		1	Coordinator performs an Energy Scan to find the quietest channel, then operates on that channel.
2	Allow Association	0	Coordinator will not allow any devices to associate to it.
		1	Coordinator allows devices to associate to it.
3 - 7	Reserved		

The binary equivalent of the default value (0x06) is 00000110. ‘Bit 0’ is the last digit of the sequence.

Default

0

AI (Association Indication)

Reads errors with the last association request.

Note Minimum firmware version required: 1.x80. Firmware versions are numbered in hexadecimal notation.

Status code	Meaning
0x00	Coordinator successfully started or End device successfully associated.
0x01	Active Scan Timeout.
0x02	Active Scan found no PANs.
0x03	Active Scan found a PAN coordinator, but the CoordinatorAllowAssociation bit is not set.

Status code	Meaning
0x04	Active Scan found a PAN, but Coordinator and End Device are not configured to support beacons.
0x05	Active Scan found a PAN, but the Coordinator ID parameter does not match the ID parameter of the End Device.
0x06	Active Scan found PAN, but the Coordinator CH parameter does not match the CH parameter of the End Device.
0x07	Energy Scan Timeout.
0x08	Coordinator start request failed.
0x09	Coordinator could not start due to invalid parameter.
0x0A	Coordinator Realignment is in progress.
0x0B	Association Request not sent.
0x0C	Association Request timed out - no reply received.
0x0D	Association Request had an invalid parameter.
0x0E	Association Request Channel Access Failure. Request was not transmitted - CCA failure.
0x0F	Remote Coordinator did not send an ACK after Association. Request was sent.
0x10	Remote Coordinator did not reply to the Association Request, but an ACK was received after sending the request.
0x11	[reserved]
0x12	Sync-Loss - Lost synchronization with a Beaconing Coordinator.
0x13	Disassociated - No longer associated to Coordinator.
0xFF	RF Module is attempting to associate.

Parameter range

0 - 0x13 [read-only]

Default

N/A

DA (Force Disassociation)

Causes the End Device to immediately disassociate from a Coordinator (if associated) and re-attempt to associate.

Parameter range

-

Default

-

FP (Force Poll)

Requests indirect messages being held by a Coordinator. The **FP** command is deferred until changes are applied. This prevents indirect messages from arriving at the end device while it is operating in Command mode.

Note Minimum firmware version required: 1.x80. Firmware versions are numbered in hexadecimal notation.

Parameter range

N/A

Default

N/A

AS (Active Scan)

Sends a Beacon Request to a Broadcast address (0xFFFF) and Broadcast PAN (0xFFFF) on every channel in **SC**. **SD** determines the amount of time the device listens for Beacons on each channel. A PanDescriptor is created and returned for every Beacon received from the scan. Each PanDescriptor contains the following information:

CoordAddress (**SH** + **SL** parameters)<CR>

Note If **MY** on the coordinator is set less than 0xFFFF, the **MY** value is displayed.

CoordPanID (**ID** parameter)<CR>

CoordAddrMode <CR>

0x02 = 16-bit Short Address

0x03 = 64-bit Long Address

Channel (**CH** parameter) <CR>

SecurityUse<CR>

ACLEntry<CR>

SecurityFailure<CR>

SuperFrameSpec<CR> (2 bytes):

bit 15 - Association Permitted (MSB)

bit 14 - PAN Coordinator

bit 13 - Reserved

bit 12 - Battery Life Extension

bits 8-11 - Final CAP Slot

bits 4-7 - Superframe Order

bits 0-3 - Beacon Order

GtsPermit<CR>

RSSI<CR> (- RSSI is returned as -dBm)

TimeStamp<CR> (3 bytes)

<CR> (A carriage return <CR> is sent at the end of the **AS** command)

The Active Scan is capable of returning up to five PanDescriptors in a scan. The actual scan time on each channel is measured as:

$$\text{Time} = [(2 \wedge (\mathbf{SD} \text{ Parameter})) * 15.36] \text{ ms.}$$

Total scan time is this time multiplied by the number of channels to be scanned (16 for the XBee and 13 for the XBee-PRO).

Refer to the scan table in [SD \(Scan Duration\)](#) to determine scan times. If using API Mode, no <CR>'s are returned in the response. For more information, see [Operate in API mode](#).

Note Minimum firmware version required: 1.x80. Firmware versions are numbered in hexadecimal notation.

Parameter range

0 - 6

Default

N/A

ED (Energy Scan)

Starts an energy detect scan. This parameter command the length of scan on each channel. The command returns the maximal energy on each channel and a carriage return follows each value. An additional carriage return is sent at the end of the command. The values returned represent the detected energy level in units of -dBm.

The actual scan time on each channel is measured as:

$$\text{Time} = [(2 \wedge \text{ED}) * 15.36] \text{ ms.}$$

The total scan time is this time multiplied by the number of channels to be scanned. For more information, see the **SD** (Scan Duration) command.

Note Minimum firmware version required: 1.x80. Firmware versions are numbered in hexadecimal notation.

Parameter range

0 - 6

Default

N/A

EE (AES Encryption Enable)

Enables or disables 128-bit Advanced Encryption Standard (AES) encryption. Use this command in conjunction with the KY command.

Note Minimum firmware version required: 1.xA0. Firmware versions are numbered in hexadecimal notation.

The firmware uses the 802.15.4 Default Security protocol and uses AES encryption with a 128-bit key. AES encryption dictates that all devices in the network use the same key, and that the maximum RF packet size is 95 bytes. If **C8**, bit 0 is not set, see [Maximum Payload](#).

When encryption is enabled, the device always uses its 64-bit long address as the source address for RF packets. This does not affect how the **MY** (Source Address), **DH** (Destination Address High) and **DL** (Destination Address Low) parameters work.

If **MM** (MAC Mode) is set to 1 or 2 and **AP** (API Enable) parameter > 0:

With encryption enabled and a 16-bit short address set, receiving devices can only issue RX (Receive) 64-bit indicators. This is not an issue when **MM** = 0 or 3.

If a device with a non-matching key detects RF data, but has an incorrect key:

When encryption is enabled, non-encrypted RF packets received are rejected and are not sent out the UART.

Parameter range

0 - 1

Parameter	Description
0	Disabled
1	Enabled

Default

0 (disabled)

KY (AES Encryption Key)

Sets the 128-bit AES link key value that the device uses for encryption and decryption. This command is write-only and cannot be read.

The command encrypts the entire payload of the packet using the key and computes the CRC across the ciphertext. When encryption is enabled, each packet carries an additional 16 bytes to convey the random CBC Initialization Vector (IV) to the receiver(s). The **KY** value may be 0 or any 128-bit value. Any other value, including entering **KY** by itself with no parameters, is invalid. The device receives all **KY** entries (valid or not) with an OK message.

When queried, the system returns an OK message and no value is returned.

Note Minimum firmware version required: 1.xA0. Firmware versions are numbered in hexadecimal notation.

Parameter range

0 - (any 16-byte value)

Default

N/A

RF interfacing commands

The following AT commands are RF interfacing commands.

PL (Power Level)

Sets or reads the power level at which the device transmits conducted power.

When operating in Europe, XBee-PRO 802.15.4 modules must operate at or below a transmit power output level of 10 dBm. Order the international variant of the XBee-PRO module, which has a maximum transmit output power of 10 dBm.

Parameter range

0 - 4

Power level	XBee Power level	XBee-PRO Power level
0	-10 dBm	10 dBm
1	-6 dBm	12 dBm
2	-4 dBm	14 dBm
3	-2 dBm	16 dBm
4	0 dBm	18 dBm

Power level	XBee-PRO international variant power level
4	10 dBm
3	8 dBm
2	2 dBm
1	-3 dBm
0	-3 dBm

Default

4

CA (CCA Threshold)

Set or read the Clear Channel Assessment (CCA) threshold. Prior to transmitting a packet, the device performs a CCA to detect energy on the channel. If the device detects energy above the CCA threshold, it will not transmit the packet.

The **CA** parameter is measured in units of -dBm.

Note Minimum firmware version required: 1.x80. Firmware versions are numbered in hexadecimal notation.

Parameter range

0x24 - 0x50 -dBm

Default

0x2C (-44 decimal dBm)

Europe

Use the following settings for Europe compliance.

Device	Hex value	Sets to level
XBee	0x34	-52 dBm

Device	Hex value	Sets to level
XBee-PRO	0x3B	-59 dBm

Sleep commands (low power)

The following AT commands are sleep commands.

SM (Sleep Mode)

Sets or reads the sleep mode of the device.

By default, Sleep Modes are disabled (**SM** = 0) and the device remains in Idle/Receive mode. When in this state, the device is constantly ready to respond to either serial or RF activity.

Parameter range

0 - 5

Parameter	Description
0	No sleep (disabled)
1	Pin hibernate
2	Pin doze
3	Reserved
4	Cyclic Sleep Remote
5	Cyclic Sleep Remote with pin wakeup
6	Sleep Coordinator ¹

Note For backwards compatibility with v1.x6 only. Otherwise, use the **CE** command.

Default

0

SO (Sleep Options)

Set or read the sleep mode options.

Parameter range

0 - 4

¹The Sleep Coordinator option (**SM**=6) exists for backwards compatibility with firmware version 1.x06 only. In all other cases, use the **CE** command to enable a Coordinator.

Bit	Setting	Meaning	Description
0	0	Normal operations	A device configured for cyclic sleep polls for data on waking.
	1	Disable wakeup poll	A device configured for cyclic sleep will not poll for data on waking.
1	0	Normal operations	A device configured in a sleep mode with ADC/DIO sampling enabled automatically performs a sampling on wakeup.
	1	Suppress sample on wakeup	A device configured in a sleep mode with ADC/DIO sampling enabled will not automatically sample on wakeup.

Default

0

ST (Time before Sleep)

Note This command applies to NonBeacon firmware.

Sets or reads the time period of inactivity (no serial or RF data is sent or received) before activating Sleep Mode.

The **ST** parameter is only valid for end devices configured with Cyclic Sleep settings (**SM** = 4 - 5).

Coordinator and End Device **ST** values must be equal.

The **GT** parameter value must always be less than the **ST** value. If **GT** > **ST**, the configuration renders the module unable to enter into command mode. If you modify the **ST** parameter, also modify the **GT** parameter accordingly.

Parameter range

1 - 0xFFFF (x 1 ms)

Default

0x1388 (5 seconds)

SP (Cyclic Sleep Period)

Note This command applies to NonBeacon firmware.

Sets and reads the duration of time that a remote device sleeps. After the cyclic sleep period is over, the device wakes and checks for data. If data is not present, the device goes back to sleep. The maximum sleep period is 268 seconds (**SP** = 0x68B0).

The **SP** parameter is only valid if you configure the end device to operate in Cyclic Sleep (**SM** = 4-6).

Coordinator and End Device **SP** values should always be equal.

To send direct messages on a coordinator, set **SP** = 0.

NonBeacon firmware

End Device: **SP** determines the sleep period for cyclic sleeping remotes. The maximum sleep period is 268 seconds (0x68B0).

Coordinator: If non-zero, **SP** determines the time to hold an indirect message before discarding it. A Coordinator discards indirect messages after a period of $(2.5 * SP)$.

Parameter range

0 - 0x68B0 (x 10 ms)

Default

0

DP (Disassociated Cyclic Sleep Period)

Note This command applies to NonBeacon firmware.

Sets or reads the sleep period for cyclic sleeping remotes that are configured for Association but that are not associated to a Coordinator. For example, if a device is configured to associate and is configured as a Cyclic Sleep remote, but does not find a Coordinator, it sleeps for **DP** time before reattempting association.

The maximum sleep period is 268 seconds (0x68B0).

DP should be > 0 for NonBeacon systems.

Note Minimum firmware version required: 1.x80. Firmware versions are numbered in hexadecimal notation.

Parameter range

1 - 0x68B0 (x 10 ms)

Default

0x3E8 (10 seconds)

Serial interfacing commands

BD (Interface Data Rate)

Set or read the serial interface data rate for communication between the serial port of the device and the host. Modified interface data rates do not take effect until you issue a **CN** (Exit AT Command Mode) command and the system returns the **OK** response.

The RF data rate is not affected by the **BD** parameter. If you set the interface data rate higher than the RF data rate, you may need to implement a flow control configuration.

To request non-standard baud rates with values above 0x80, use a terminal window. Read the **BD** register to find actual baud rate achieved.

Non-standard interface data rates

The firmware interprets any value above 0x07 as an actual baud rate. When the firmware cannot configure the exact rate specified, it configures the closest approximation to that rate. For example, to set a rate of 19200 b/s send the following command line: **ATBD4B00**.

Note When using XCTU, you can only set and read non-standard interface data rates using the **XCTU Terminal** tab. You cannot access non-standard rates through the **Modem Configuration** tab.

When you send the **BD** command with a non-standard interface data rate, the UART adjusts to accommodate the interface rate you request. In most cases, the clock resolution causes the stored **BD** parameter to vary from the sent parameter. Sending **ATBD** without an associated parameter value returns the value actually stored in the device's **BD** register.

The following table provides the parameters sent versus the parameters stored.

BD parameter sent (HEX)	Interface data rate (b/s)	BD parameter stored (HEX)
0	1200	0
4	19,200	4
7	115,200*	7
12C	300	12B
1C200	115,200	1B207

* The 115,200 baud rate setting is actually at 111,111 baud (-3.5% target UART speed).

Parameter range

0 - 7 (standard baud rates)

0x80 - 0x3D090 (non-standard baud rates up to 250 kb/s)

Values from 0 to 7 are interpreted as follows:

Parameter	Description
0x0	1200 b/s
0x1	2400 b/s
0x2	4800 b/s
0x3	9600 b/s
0x4	19200 b/s
0x5	38400 b/s
0x6	57600 b/s
0x7	115200 b/s

Default

0x03 (9600 b/s)

RO (Packetization Timeout)

Set or read the number of character times of inter-character silence required before transmission.

RF transmission starts when the device detects data in the **DI** (data in from host) buffer and **RO** character times of silence are detected on the UART receive lines (after receiving at least 1 byte).

RF transmission also starts after 100 bytes (maximum packet size) are received in the **DI** buffer.

Set **RO** to 0 to transmit characters as they arrive instead of buffering them into one RF packet.

Parameter range

0 - 0xFF (x character times)

Default

3

AP (API Enable)

Disable or Enable API mode to operate using a frame-based API instead of using the default Transparent (UART) mode. For more information, see [Operate in API mode](#).

Note Minimum firmware version required: 1.x80. Firmware versions are numbered in hexadecimal notation.

Parameter range

0 - 2

Parameter	Description
0	API disabled (operate in Transparent mode)
1	API enabled
2	API enabled (with escaped control characters)

Default

0

NB (Parity)

The device does not actually calculate and check the parity. It only interfaces with devices at the configured parity and stop bit settings.

Parameter range

0x00 - 0x04

Default

0x00

PR (Pull-up/Down Resistor Enable)

The bit field that configures the internal pull-up resistor status for the I/O lines.

Note Minimum firmware version required: 1.x80. Firmware versions are numbered in hexadecimal notation.

Bit	I/O line
0	AD4/DIO4 (pin 11)

Bit	I/O line
1	AD3/DIO3 (pin 17)
2	AD2/DIO2 (pin 18)
3	AD1/DIO1 (pin 19)
4	AD0/DIO0 (pin 20)
5	$\overline{\text{RTS}}$ /DIO6 (pin 16)
6	DI8/SLEEP_RQ (pin 9)
7	DIN/CONFIG (pin 3)

If you set a **PR** bit to 1, it enables the pull-up resistor. If you set a **PR** bit to 0, it specifies no internal pull-up.

Parameter range

0 - 0xFF

Default

0xFF

Example

Sending the command **ATPR 6F** turn bits 0, 1, 2, 3, 5 and 6 ON, and bits 4 and 7 OFF. The binary equivalent of **0x6F** is **01101111**. Bit 0 is the last digit in the bit field.

I/O settings commands

The following AT commands are I/O settings commands.

DO (DIO0 Configuration)

Sets or reads the function of AD0/DIO0 (pin 20).

The options include analog-to-digital converter, digital input, and digital output.

Note Minimum firmware version required: 1.xA0. Firmware versions are numbered in hexadecimal notation.

Parameter range

0 - 1

Parameter	Description
0	Disabled
1	N/A
2	ADC

Parameter	Description
3	Digital input
4	Digital output, low
5	Digital output, high

Default

0

D1 (DIO1 Configuration)

Set or read the function for the AD1/DIO1 configuration (pin 19).

The options include analog-to-digital converter, digital input, and digital output.

Parameter range

0 - 1

Parameter	Description
0	Disabled
1	N/A
2	ADC
3	Digital input
4	Digital output, low
5	Digital output, high

Default

0

D2 (DIO2 Configuration)

Select or read the function for AD2/DIO2 (pin 18).

The options include analog-to-digital converter, digital input, and digital output.

Parameter range

0 - 1

Parameter	Description
0	Disabled
1	N/A

Parameter	Description
2	ADC
3	Digital input
4	Digital output, low
5	Digital output, high

Default

0

D3 (DIO3 Configuration)

Select or read the function for AD3/ DIO3 (pin 17).

The options include analog-to-digital converter, Digital Input, and Digital Output.

Note Minimum firmware version required: 1.xA0. Firmware versions are numbered in hexadecimal notation.

Parameter range

0 - 1

Parameter	Description
0	Disabled
1	N/A
2	ADC
3	Digital input
4	Digital output, low
5	Digital output, high

Default

0

D4 (DIO4 Configuration)

Select or read the function for DIO4 (pin 11).

The options include analog-to-digital converter, digital input, and digital output.

Note Minimum firmware version required: 1.xA0. Firmware versions are numbered in hexadecimal notation.

Parameter range

0 - 1

Parameter	Description
0	Disabled
1	N/A
2	ADC
3	Digital input
4	Digital output, low
5	Digital output, high

Default

0

D5 (DIO5 Configuration)

Configure settings for the DIO5 line (pin 15) of the RF module.

The options include an Associate LED indicator (blinks when associated), analog-to-digital converter, and I/O line settings.

Note Minimum firmware version required: 1.x80. Firmware versions are numbered in hexadecimal notation.

Parameter range

0 - 1

Parameter	Description
0	Disabled
1	Associate LED indicator - blinks when associated
2	ADC
3	Digital input
4	Digital output, default low
5	Digital output, default high

Default

1

D6 (DIO6 Configuration)

Sets or displays the DIO6/ $\overline{\text{RTS}}$ pin configuration (pin 16).

The options include RTS flow control, analog-to-digital converter, and I/O line settings.

Note Minimum firmware version required: 1.x80. Firmware versions are numbered in hexadecimal notation.

Parameter range

0 - 1

Parameter	Description
0	Disabled
1	RTS flow control
2	N/A
3	Digital input
4	Digital output, low
5	Digital output, high

Default

0

D7 (DIO7 Configuration)

Sets or displays the DIO7/ $\overline{\text{CTS}}$ pin configuration (pin 12).

The options include $\overline{\text{CTS}}$ flow control, analog-to-digital converter, I/O line settings, and RS-485 TX Enable command (this output is 3 V CMOS level, and is useful in a 3 V CMOS to RS-485 conversion circuit)(D18 configuration).

Note Minimum firmware version required: 1.x80. Firmware versions are numbered in hexadecimal notation.

Parameter range

0 - 1

Parameter	Description
6	RS-485 Tx enable, low Tx
7	RS-485 Tx enable high, high Tx

Default

1

D8 (DIO8 Configuration)

Set or read options for the DIO8 pin (pin 4).

This command enables you to configure the pin to function as a digital input. This line is also used with Pin Sleep.

Parameter range

0 - 1

Parameter	Description
0	Disabled
1	N/A
2	N/A
3	Digital input
4	N/A
5	N/A

Default

0

IU (I/O Output Enable)

The **IU** command disables or enables I/O UART output. When enabled (**IU** = 1), received I/O line data packets are sent out the UART. The data is sent using an API frame regardless of the current **AP** parameter value.

Note Minimum firmware version required: 1.xA0. Firmware versions are numbered in hexadecimal notation.

Parameter range

0 - 1

0, 1

Parameter	Description
0	Disabled
1	Enabled

Default

1

IT (Samples before TX)

Sets or reads the number of samples to collect before transmitting data. The maximum number of samples is dependent on the number of enabled I/O lines and the maximum payload available.

If **IT** is set to a number too big to fit in the maximum payload, it is reduced such that it will fit in a single frame. No more than 44 samples can fit in a single frame or **IT**=0x2C.

One ADC sample is considered complete when all enabled ADC channels have been read. The device can buffer up to 88 bytes of sample data. Since the module uses a 10-bit A/D converter, each sample uses two bytes.

When Sleep Modes are enabled and **IR** (Sample Rate) is set, the device remains awake until **IT** samples have been collected.

Note Minimum firmware version required: 1.xA0. Firmware versions are numbered in hexadecimal notation.

Parameter range

1 - 0xFF

Default

1

IS (Force Sample)

Force a read of all enabled inputs (DI or ADC). The command returns data through the UART. If no inputs are defined (DI or ADC), the command returns and error.

Note Minimum firmware version required: 1.xA0. Firmware versions are numbered in hexadecimal notation.

When operating in Transparent mode (**AP** = 0), the data is returned in the following format:

All bytes are converted to ASCII:

number of samples<CR>

channel mask<CR>

DIO data<CR> (If DIO lines are enabled)

ADC channel Data<CR> (This will repeat for every enabled ADC channel)

<CR> (end of data noted by extra <CR>)

When operating in API mode (**AP** = 1), the command immediately returns an **OK** response. The data follows in the normal API format for DIO data.

Parameter range

N/A

Default

N/A

I/O (Digital Output Level)

Sets digital output levels. This allows DIO lines setup as outputs to be changed through Command Mode.

Note Minimum firmware version required: 1.xA0. Firmware versions are numbered in hexadecimal notation.

Parameter range

8-bit bit map; each bit represents the level of an I/O line set up as an output

Default

N/A

IC (DIO Change Detect)

Set or read the digital I/O pins to monitor for changes in the I/O state.

Each bit enables monitoring of DIO0 - DIO7 for changes. If detected, data is transmitted with DIO data only. Any samples queued waiting for transmission is sent first.

See [ADC and Digital I/O line support](#) for more information about the **IC** command.

Note Minimum firmware version required: 1.xA0. Firmware versions are numbered in hexadecimal notation.

Parameter range

0 - 0xFF (bit field)

Default

0 (disabled)

IR (Sample Rate)

Set or read the I/O sample rate to enable periodic sampling. When set, this parameter samples all enabled DIO/ADC lines at a specified interval.

This command allows periodic reads of the ADC and DIO lines in a non-Sleep Mode setup. We do not recommend a sample rate that requires transmissions at a rate greater than once every 20 ms.

Example: When IR = 0x14, the sample rate is 20 ms (or 50 Hz).

Note Minimum firmware version required: 1.xA0. Firmware versions are numbered in hexadecimal notation.

If you set the I/O sample rate to greater than 0, the device samples and transmits all enabled digital I/O and analog inputs every **IR** milliseconds. I/O Samples transmit to the address specified by **DT**.

Parameter range

0 - 0xFFFF (x 1 ms)

Default

0

IA (I/O Input Address)

Sets or reads addresses of module to which outputs are bound. Setting all bytes to 0xFF will not allow any received I/O packet to change outputs. Setting the address to 0xFFFF allows any received I/O packet to change outputs.

You can use the **IA** command to set or read both 16 and 64-bit addresses.

Note Minimum firmware version required: 1.xA0. Firmware versions are numbered in hexadecimal notation.

Parameter range

0 - 0xFFFFFFFFFFFFFFFF

Default**T0 (D0 Output Timeout)**

Sets or reads output timeout values for lines that correspond with the D0 parameter. When the output is set (due to I/O line passing) to a non-default level, a timer starts that sets the output to its default level when it expires. The timer resets when a valid I/O packet is received.

The **Tn** parameter defines the permissible amount of time to stay in a non-default (active) state. If **Tn** = 0, Output Timeout is disabled (output levels are held indefinitely).

Note Minimum firmware version required: 1.xA0. Firmware versions are numbered in hexadecimal notation.

Parameter range

0 - 0xFF (x 100 ms)

Default

0xFF

T1 (D1 Output Timeout)

Sets or reads output timeout values for lines that correspond with the D1 parameter. When the output is set (due to I/O line passing) to a non-default level, a timer starts that sets the output to its default level when it expires. The timer resets when a valid I/O packet is received.

The **Tn** parameter defines the permissible amount of time to stay in a non-default (active) state. If **Tn** = 0, Output Timeout is disabled (output levels are held indefinitely).

Note Minimum firmware version required: 1.xA0. Firmware versions are numbered in hexadecimal notation.

Parameter range

0 - 0xFF (x 100 ms)

Default

0xFF

T2 (D2 Output Timeout)

Sets or reads output timeout values for lines that correspond with the D2 parameter. When the output is set (due to I/O line passing) to a non-default level, a timer starts that sets the output to its default level when it expires. The timer resets when a valid I/O packet is received.

The **Tn** parameter defines the permissible amount of time to stay in a non-default (active) state. If **Tn** = 0, Output Timeout is disabled (output levels are held indefinitely).

Note Minimum firmware version required: 1.xA0. Firmware versions are numbered in hexadecimal notation.

Parameter range

0 - 0xFF (x 100 ms)

Default

0xFF

T3 (D3 Output Timeout)

Sets or reads output timeout values for lines that correspond with the D3 parameter. When the output is set (due to I/O line passing) to a non-default level, a timer starts that sets the output to its default level when it expires. The timer resets when a valid I/O packet is received.

The **Tn** parameter defines the permissible amount of time to stay in a non-default (active) state. If **Tn** = 0, Output Timeout is disabled (output levels are held indefinitely).

Note Minimum firmware version required: 1.xA0. Firmware versions are numbered in hexadecimal notation.

Parameter range

0 - 0xFF (x 100 ms)

Default

0xFF

T4 (D4 Output Timeout)

Sets or reads output timeout values for lines that correspond with the D4 parameter. When the output is set (due to I/O line passing) to a non-default level, a timer starts that sets the output to its default level when it expires. The timer resets when a valid I/O packet is received.

The **Tn** parameter defines the permissible amount of time to stay in a non-default (active) state. If **Tn** = 0, Output Timeout is disabled (output levels are held indefinitely).

Note Minimum firmware version required: 1.xA0. Firmware versions are numbered in hexadecimal notation.

Parameter range

0 - 0xFF (x 100 ms)

Default

0xFF

T5 (D5 Output Timeout)

Sets or reads output timeout values for lines that correspond with the D5 parameter. When the output is set (due to I/O line passing) to a non-default level, a timer starts that sets the output to its default level when it expires. The timer resets when a valid I/O packet is received.

The **Tn** parameter defines the permissible amount of time to stay in a non-default (active) state. If **Tn** = 0, Output Timeout is disabled (output levels are held indefinitely).

Note Minimum firmware version required: 1.xA0. Firmware versions are numbered in hexadecimal notation.

Parameter range

0 - 0xFF (x 100 ms)

Default

0xFF

T6 (D6 Output Timeout)

Sets or reads output timeout values for lines that correspond with the D6 parameter. When the output is set (due to I/O line passing) to a non-default level, a timer starts that sets the output to its default level when it expires. The timer resets when a valid I/O packet is received.

The **Tn** parameter defines the permissible amount of time to stay in a non-default (active) state. If **Tn** = 0, Output Timeout is disabled (output levels are held indefinitely).

Note Minimum firmware version required: 1.xA0. Firmware versions are numbered in hexadecimal notation.

Parameter range

0 - 0xFF (x 100 ms)

Default

0xFF

T7 (D7 Output Timeout)

Sets or reads output timeout values for lines that correspond with the D7 parameter. When the output is set (due to I/O line passing) to a non-default level, a timer starts that sets the output to its default level when it expires. The timer resets when a valid I/O packet is received.

The **Tn** parameter defines the permissible amount of time to stay in a non-default (active) state. If **Tn** = 0, Output Timeout is disabled (output levels are held indefinitely).

Note Minimum firmware version required: 1.xA0. Firmware versions are numbered in hexadecimal notation.

Parameter range

0 - 0xFF (x 100 ms)

Default

0xFF

P0 (PWM0 Configuration)

Select or read the function for PWM0.

This command enables the option of translating incoming data to a PWM so that the output can be translated back into analog form.

If the **IA** (I/O Input Address) parameter is correctly set and **P0** is configured as PWM0 output, incoming AD0 samples automatically modify the PWM0 value.

Parameter range

0 - 2

Parameter	Description
0	Disabled
1	RSSI
2	PWM0 output

Default

1

P1 (PWM1 Configuration)

The DIO11/PWM1 pin configuration (pin 7).

Select or read the function for PWM1. This command enables the option of translating incoming data to a PWM so that the output can be translated back into analog form.

If **IA** (I/O Input Address) is correctly set and **P1** is configured as PWM1 output, incoming AD1 samples automatically modify the PWM1 value.

Note Minimum firmware version required: 1.xA0. Firmware versions are numbered in hexadecimal notation.

Parameter range

0, 2

Parameter	Description
0	Disabled
1	N/A
2	PWM1 output

Default

0

M0 (PWM0 Output Level)

Sets or reads output level of the PWM0 line (pin 6).

Before setting the line as an output:

1. Enable PWM0 output (**P0** = 2).
2. Apply settings (use **CN** or **AC**).

The PWM period is 64 μ s and there are 0x03FF (1023 decimal) steps within this period. When **M0** = 0 (0% PWM), 0x01FF (50% PWM), 0x03FF (100% PWM), and so forth.

Note Minimum firmware version required: 1.xA0. Firmware versions are numbered in hexadecimal notation.

Parameter range

0 - 0x3FF

Default

0

M1 (PWM1 Output Level)

Sets or reads the PWM1 output level (pin 7).

Before setting the line as an output:

1. Enable PWM1 output (**P1** = 2).
2. Apply settings (use **CN** or **AC**)

Note Minimum firmware version required: 1.xA0. Firmware versions are numbered in hexadecimal notation.

Parameter range

0 - 0x3FF

Default

0

PT (PWM Output Timeout)

Sets or reads the output timeout value for both PWM outputs. When PWM is set to a non-zero value (due to I/O line passing), a timer starts that sets the PWM output to zero when it expires. The timer resets when it receives a valid I/O packet.

Note Minimum firmware version required: 1.xA0. Firmware versions are numbered in hexadecimal notation.

Parameter range

0 - 0xFF (x 100 ms)

Default

0xFF

RP (RSSI PWM Timer)

The following table shows dB levels above sensitivity and PWM values. The total time period of the PWM output is 8.32 ms. PWM output consists of 40 steps, so the minimum step size is 0.208 ms.

Enables a pulse-width modulated (PWM) output on the RF device. We calibrate the pin to show the difference between received signal strength and the sensitivity level of the device. PWM pulses vary from 24 to 100 percent. Zero percent means PWM output is inactive. One to 24% percent means the received RF signal is at or below the published sensitivity level of the module.

The following table shows dB levels above sensitivity and PWM values. The total time period of the PWM output is 64 μ s. PWM output consists of 445 steps, so the minimum step size is 144 ms.

dB above sensitivity	PWM percentage (high period / total period)
10	41%
20	58%
30	75%

A non-zero value defines the time that PWM output is active with the RSSI value of the last RF packet the device receives. After the set time when the device has not received RF packets, it sets the PWM output low (0 percent PWM) until the device receives another RF packet. It also sets PWM output low at power-up. A parameter value of 0xFF permanently enables PWM output and always reflects the value of the last received RF packet.

Parameter range

0 - 0xFF [x 100 ms]

Default

0x28 (4 seconds)

Diagnostic commands

VR (Firmware Version)

Reads the firmware version on a device.

Firmware version numbers have four significant digits. The reported number shows three or four numbers in hexadecimal notation. A version is reported as **ABCD**. Digits ABC are the main release number and D is the revision number from the main release. **D** is not required and if it is not present, a zero is assumed for **D**. **B** is a variant designator.

The following variants exist:

- 0 = Non-Beacon Enabled 802.15.4 Code
- 1 = Beacon Enabled 802.15.4 Code

Parameter range

0 - 0xFFFF [read-only]

Default

Set in the factory

VL (Version Long)

Shows detailed version information including the application build date, MAC, PHY, and bootloader versions. The **VL** command has been deprecated in version 10C9. It is not supported in firmware versions after 10C8.

Note Minimum firmware version required: 1.xA0. Firmware versions are numbered in hexadecimal notation.

Parameter range

N/A

Default

N/A

HV (Hardware Version)

Display the device's hardware version number.

Note Minimum firmware version required: 1.x80. Firmware versions are numbered in hexadecimal notation.

Parameter range

0 - 0xFFFF [read-only]

Default

Set in the factory

DB (Last Packet RSSI)

The command measures RSSI in -dBm of last good packet received. The command reports the absolute value. For example: If 0x58 = -88 dBm, the reported value is accurate between -40 dBm and RX sensitivity. If no packets have been received since last reset, power cycle or sleep event, the command reports **0**.

Parameter range

0x17 - 0x5C (XBee) [read-only]

0x24 - 0x64 (XBee-PRO) [read-only]

Default

N/A

EC (CCA Failures)

Resets or reads the count of Clear Channel Assessment (CCA) failures. This register increments when the device does not transmit a packet because it detected energy above the CCA threshold level set with **CA** command. This count saturates at its maximum value. Set the count to zero to reset the count.

Note Minimum firmware version required: 1.x80. Firmware versions are numbered in hexadecimal notation.

Parameter range

0 - 0xFFFF

Default

N/A

EA (ACK Failures)

Resets or reads the count of acknowledgment failures. This register increments when the device expires the retries without receiving an ACK on a packet transmission. This count saturates at its

maximum value. Set the count to zero to reset the count.

Note Minimum firmware version required: 1.x80. Firmware versions are numbered in hexadecimal notation.

Parameter range

0 - 0xFFFF

Default

N/A

ED (Energy Scan)

Starts an energy detect scan. This parameter command the length of scan on each channel. The command returns the maximal energy on each channel and a carriage return follows each value. An additional carriage return is sent at the end of the command. The values returned represent the detected energy level in units of -dBm.

The actual scan time on each channel is measured as:

$$\text{Time} = [(2 \wedge \text{ED}) * 15.36] \text{ ms.}$$

The total scan time is this time multiplied by the number of channels to be scanned. For more information, see the **SD** (Scan Duration) command.

Note Minimum firmware version required: 1.x80. Firmware versions are numbered in hexadecimal notation.

Parameter range

0 - 6

Default

N/A

Command mode options

The following commands are Command mode option commands.

CT (Command Mode Timeout)

Sets or reads the Command mode timeout parameter. If a device does not receive any valid commands within this time period, it returns to Idle mode from Command mode.

Use the **CN** (Exit Command Mode) command to exit Command Mode manually.

Parameter range

2 - 0xFFFF (x 100 ms)

Default

0x64 (10 seconds)

CN (Exit Command mode)

Makes the device exit Command mode.

Parameter range

N/A

Default

N/A

AC (Apply Changes)

Apply changes to queued parameter values and re-initialize the device.

Applying changes means that the device is re-initialized based on changes made to its parameter values. Once changes are applied, the device immediately operates according to the new parameter values.

This behavior is in contrast to issuing the **WR** (Write) command. The **WR** command saves parameter values to non-volatile memory, but the device still operates according to previously saved values until the device is rebooted or the **CN** (Exit AT Command Mode) is issued. For more information, see [AT Command - Queue Parameter Value frame - 0x09](#).

Note Minimum firmware version required: 1.xA0. Firmware versions are numbered in hexadecimal notation.

Parameter range

N/A

Default

N/A

GT (Guard Times)

Set the required period of silence before and after the command sequence characters of the Command mode sequence (**GT + CC + GT**). The period of silence prevents inadvertently entering Command mode.

See [Command mode options](#) for more information about AT Command mode.

Parameter range

2 - 0xCE4 (x 1 ms)

Default

0x3E8 (one second)

CC (Command Sequence Character)

Sets or reads the ASCII character value the device uses between Guard Times of the AT Command Mode Sequence (**GT + CC + GT**). The AT Command Mode Sequence enters the device into AT Command Mode so the device recognizes data entering from the host as commands instead of payload.

For more information about AT Command Mode sequence, see [Command mode options](#).

Parameter range

0 - 0xFF

Default

0x2B (ASCII + character)

API operation

By default, XBee/XBee-PRO RF Modules act as a serial line replacement (Transparent Operation). All UART data received through the DI pin is queued up for RF transmission. When the module receives an RF packet, it sends the data out the DO pin with no additional information.

The following behaviors are Inherent to Transparent Operation:

- If device parameter registers need to be set or queried, transitioning the module into Command Mode requires a special operation.
- In point-to-multipoint systems, the application must send extra information so the receiving devices can distinguish between data coming from different remotes.

The Application Programming Interface (API) operations are available as an alternative to the default Transparent Operation. API operation requires communication with the device through a structured interface where data is communicated in frames in a defined order. The API specifies how commands, command responses, and status messages are sent and received from the device using a UART data frame.

API frame specifications	85
Calculate and verify checksums	86
API types	86

API frame specifications

The firmware supports two API operating modes: without escaped characters and with escaped characters. Use the **AP** command to enable either mode. To configure a device to one of these modes, set the following **AP** parameter values:

AP command setting	Description
AP = 0	Transparent operating mode, UART serial line replacement with API modes disabled. This is the default option.
AP = 1	API operation.
AP = 2	API operation with escaped characters (only possible on UART).

The API data frame structure differs depending on what mode you choose.

The firmware silently discards any data it receives prior to the start delimiter. If the device does not receive the frame correctly or if the checksum fails, the device discards the frame.

API operation (AP parameter = 1)

We recommend this API mode for most applications. The following table shows the data frame structure when you enable this mode:

Frame fields	Byte	Description
Start delimiter	1	0x7E
Length	2 - 3	Most Significant Byte, Least Significant Byte
Frame data	4 - n	API-specific structure
Checksum	n + 1	1 byte

API operation-with escaped characters (AP parameter = 2)

Set API to 2 to allow escaped control characters in the API frame. Due to its increased complexity, we only recommend this API mode in specific circumstances. API 2 may help improve reliability if the serial interface to the device is unstable or malformed frames are frequently being generated.

When operating in API 2, if an unescaped 0x7E byte is observed, it is treated as the start of a new API frame and all data received prior to this delimiter is silently discarded. For more information on using this API mode, refer to the following knowledge base article:

http://knowledge.digi.com/articles/Knowledge_Base_Article/Escaped-Characters-and-API-Mode-2

The following table shows the structure of an API frame with escaped characters:

Frame fields	Byte	Description
Start delimiter	1	0x7E

Frame fields	Byte	Description	
Length	2 - 3	Most Significant Byte, Least Significant Byte	Characters escaped if needed
Frame data	4 - n	API-specific structure	
Checksum	n + 1	1 byte	

Escape characters

When sending or receiving a UART data frame, you must escape (flag) specific data values so they do not interfere with the data frame sequencing. To escape an interfering data byte, insert 0x7D and follow it with the byte to be escaped XOR'd with 0x20. If not escaped, 0x11 and 0x13 are sent as is.

Data bytes that need to be escaped:

- 0x7E – Frame delimiter
- 0x7D – Escape
- 0x11 – XON
- 0x13 – XOFF

Example - Raw UART data frame (before escaping interfering bytes): 0x7E 0x00 0x02 0x23 0x11 0xCB
0x11 needs to be escaped which results in the following frame: 0x7E 0x00 0x02 0x23 0x7D 0x31 0xCB

Note In the previous example, the length of the raw data (excluding the checksum) is 0x0002 and the checksum of the non-escaped data (excluding frame delimiter and length) is calculated as:
 $0xFF - (0x23 + 0x11) = (0xFF - 0x34) = 0xCB$.

Calculate and verify checksums

To calculate the checksum of an API frame:

1. Add all bytes of the packet, except the start delimiter 0x7E and the length (the second and third bytes).
2. Keep only the lowest 8 bits from the result.
3. Subtract this quantity from 0xFF.

To verify the checksum of an API frame:

1. Add all bytes including the checksum; do not include the delimiter and length.
2. If the checksum is correct, the last two digits on the far right of the sum equal 0xFF.

API types

This field contains the information that a device receives or transmits. The structure of frame data depends on the purpose of the API frame:

Start delimiter	Length		API identifier	Frame data							Checksum
				Identifier-specific Data							
1	2	3	4	5	6	7	8	9	...	n	n+1
0x7E	MSB	LSB	cmdID	cmdData							Single byte

The cmdID frame (API-identifier) indicates which API messages contains the cmdData frame (Identifier-specific data). The device sends multi-byte values big endian format.

Modem Status frame - 0x8A

Description

Devices send the status messages in this frame in response to specific conditions.

Format

The following table provides the contents of the frame. For details on frame structure, see [API frame specifications](#).

Frame data fields	Offset	Description
Frame type	3	0x8A
Status	5	0 = Hardware reset 1 = Watchdog timer reset 2 = Associated 3 = Disassociated 4 = Synchronization lost (Beacon-enabled only) 5 = Coordinator realignment 6 = Coordinator started

AT Command Frame - 0x08

Description

Use this frame to query or set device parameters on the local device. This API command applies changes after running the command. This includes any register set with [AT Command - Queue Parameter Value frame - 0x09](#).

Format

The following table provides the contents of the frame. For details on frame structure, see [API frame specifications](#).

Frame data fields	Offset	Description
Frame type	4	0x08
Frame ID	5	Identifies the UART data frame for the host to correlate with a subsequent ACK (0x88). If set to 0 , the device does not send a response.
AT command	6-7	Command name: two ASCII characters that identify the AT command.
Parameter value	8-n	If present, indicates the requested parameter value to set the given register. If no characters are present, it queries the register.

Example

The following example illustrates an AT Command frame when you modify the device's **DL** parameter value.

Frame data fields	Offset	Example
Start delimiter	0	0x7E
Length	MSB 1	0x00
	LSB 2	0x08
Frame type	3	0x08
Frame ID	4	0x4D (M) ¹
AT command	5	0x44 (D)
	6	0x4C (L)
Parameter value	7-10	0x00000FFF
Checksum	11	0x0C

AT Command - Queue Parameter Value frame - 0x09

Description

This frame allows you to query or set device parameters. In contrast to the AT Command (0x08) frame, this frame queues new parameter values and does not apply them until you issue either:

- The **AT** Command (0x08) frame (for API type)
- The **AC** command

The device returns register queries immediately and does not queue them.

¹M was arbitrarily selected.

AT Command Response frame - 0x88

Description

A device sends this frame in response to an AT Command message. Some commands send back multiple frames (for example, the **ND** (Node Discover) and **AS** (Active Scan) commands). These commands end by sending a frame with a status of ATCMD_OK and no cmdData.

Format

The following table provides the contents of the frame. For details on frame structure, see [API frame specifications](#).

Frame data fields	Offset	Description
Frame type	4	0x88
Frame ID	5	Identifies the data frame being reported. If set to 0 , the device does not send a response.
AT command	6-7	Command name: two ASCII characters that identify the AT command.
Status	8	0 = OK 1 = ERROR 2 = Invalid command 3 = Invalid parameter
Command data	9-n	The register data in hexadecimal format.

Remote AT Command Request frame - 0x17

Description

Used to query or set device parameters on a remote device.

Format

The following table provides the contents of the frame. For details on frame structure, see [API frame specifications](#).

Frame data fields	Offset	Description
Frame type	4	0x17
Frame ID	5	Identifies the UART data frame for the host to correlate with a subsequent ACK. If set to 0 , the device does not send a response.
64-bit destination address	6-13	MSB first, LSB last. Set to the 64-bit address of the destination device. Broadcast = 0x000000000000FFFF. If the 16-bit parameter has a different value from 0xFFFE the device uses the 64-bit address is used. Otherwise, it uses the 16-bit address.

Frame data fields	Offset	Description
16-bit destination address	14-15	Set to 0xFFFE if the 64-bit address is being used.
Remote command options	16	0x02 = Apply changes on remote. If you do not set this, you must send the AC command for changes to take effect. Set all other bits to 0.
AT command	17-18	The name of the command. Two ASCII characters identify the command.
Command data	19-n	If present, indicates the parameter value you request for a given register. If no characters are present, it queries the register.

Remote Command Response frame - 0x97

Description

If a device receives this frame in response to a Remote Command Request (0x17) frame, the device sends an AT Command Response (0x97) frame out the serial interface.

Some commands, such as the **ND** command, may send back multiple frames.

Format

The following table provides the contents of the frame. For details on frame structure, see [API frame specifications](#).

Frame data fields	Offset	Description
Frame type	4	0x97
Frame ID	5	Identifies the UART data frame being reported. This is the same value that is passed in to the request.
64-bit source (remote) address	6-13	The 64-bit address of the remote device returning this response.
16-bit source (remote) address	14-15	
AT Command	16-17	The name of the command. Two ASCII characters identify the AT command.
Status	18	0 = OK 1 = ERROR 2 = Invalid Command 3 = Invalid Parameter
Command data	19-n	The value of the requested register.

TX Request: 64-bit address frame - 0x00

Description

This frame causes the device to send payload data as an RF packet.

Format

The following table provides the contents of the frame. For details on frame structure, see [API frame specifications](#).

Frame data fields	Offset	Description
Frame type	4	0x00
Frame ID	5	Identifies the UART data frame for the host to correlate with a subsequent ACK. If set to 0 , the device does not send a response.
Destination address	6-13	MSB, first, and LSB last. Broadcast = 0x000000000000FFFF
Options	14	0x01 = Disable ACK 0x04 = Send packet with Broadcast PAN ID All other bits must be set to 0 .
RF data	15-n	Up to 100 bytes per packet.

TX Request: 16-bit address - 0x01

Description

A TX Request message causes the device to transmit data as an RF Packet.

Format

The following table provides the contents of the frame. For details on frame structure, see [API frame specifications](#).

Frame data fields	Offset	Description
Frame type	4	0x01
Frame ID	5	Identifies the UART data frame for the host to correlate with a subsequent ACK (0x89). If set to 0 , the device does not send a response.
16-bit destination address	6-7	MSB first, LSB last. Broadcast = 0xFFFF.
Options	8	0x01 = Disable ACK. 0x04 = Send packet with Broadcast PAN ID. Set all other bits to 0 .
RF data	9-n	Up to 100 bytes per packet.

TX Status frame - 0x89

Description

When a TX Request is complete, the device sends a TX Status frame. This message indicates if the packet transmitted successfully or if there was a failure.

Format

The following table provides the contents of the frame. For details on frame structure, see [API frame specifications](#).

Frame data fields	Offset	Description
Frame type	4	0x89
Frame ID	5	Identifies the UART data frame being reported.
Status	6	0 = success 1 = no ACK received 2 = CCA failure 3 = purged

Notes:

- STATUS = 1 occurs when all retries are expired and no ACK is received.
- If transmitter broadcasts (destination address = 0x000000000000FFFF), only STATUS = 0 or 2 is returned.
- STATUS = 3 occurs when Coordinator times out of an indirect transmission. Timeout is defined as (2.5 x **SP** (Cyclic Sleep Period) parameter value).

RX (Receive) packet: 64-bit address frame - 0x80

Description

When a device receives an RF data packet, it sends this frame out the UART.

Format

The following table provides the contents of the frame. For details on frame structure, see [API frame specifications](#).

Frame data fields	Offset	Description
Frame type	4	0x80
Source address	5-12	MSB first, LSB last.

Frame data fields	Offset	Description
RSSI	13	Received Signal Strength Indicator. The Hexadecimal equivalent of (-dBm) value. For example if RX signal strength is -40 dBm, then 0x28 (40 decimal) is returned.
Options	14	Bit field: bit 0: Reserved bit 1: Address broadcast bit 2: PAN broadcast bits 3-7: Reserved
RF data	15-n	Up to 100 bytes per packet.

RX (Receive) packet 16-bit address frame - 0x81

Description

When a device receives an RF data packet, it sends this frame out the UART.

Format

The following table provides the contents of the frame. For details on frame structure, see [API frame specifications](#).

Frame data fields	Offset	Description
Frame type	4	0x81
Source address	5-6	MSB first, LSB last.
RSSI	7	Received Signal Strength Indicator. The Hexadecimal equivalent of (-dBm) value. For example if RX signal strength is -40 dBm, then 0x28 (40 decimal) is returned.
Options	8	Bit field: bit 0: Reserved bit 1: Address broadcast bit 2: PAN broadcast bits 3-7: Reserved
RF data	9-n	Up to 100 bytes per packet.

RX (Receive) Packet: 64-bit address IO frame- 0x82

Description

When the device receives an I/O sample from a remote device configured to use 64-bit addressing, the I/O data is sent out the UART using this frame type

Format

The following table provides the contents of the frame. For details on frame structure, see [API frame specifications](#).

Frame data fields	Offset	Description
Frame type	4	0x82
Source address	5-12	MSB first, LSB last.
RSSI	13	Received Signal Strength Indicator. The Hexadecimal equivalent of (-dBm) value. For example if RX signal strength is -40 dBm, then 0x28 (40 decimal) is returned.
Options	14	Bit field: bit 0: Reserved bit 1: Address broadcast bit 2: PAN broadcast bits 3-7: Reserved
RF data	15-n	Up to 100 bytes per packet.

The following table shows the Channel Indicator and Digital Samples bit fields.

Bit field	Description
Reserved	3 bits
A3 - A0	4 analog bits
D8 - D0	9 digital bits

RX Packet: 16-bit address I/O frame - 0x83

Description

When the device receives an I/O sample from a remote device configured to use 16-bit addressing, the I/O data is sent out the UART using this frame type.

Format

The following table provides the contents of the frame. For details on frame structure, see [API frame specifications](#).

Frame data fields	Offset	Description
Frame type	4	0x81
Source address	5-6	MSB first, LSB last.
RSSI	7	Received Signal Strength Indicator. The Hexadecimal equivalent of (-dBm) value. For example if RX signal strength is -40 dBm, then 0x28 (40 decimal) is returned.
Options	8	Bit field: bit 0: Reserved bit 1: Address broadcast bit 2: PAN broadcast bits 3-7: Reserved
RF data	9-n	Up to 100 bytes per packet.

Certifications

United States (FCC)	97
Europe	104
Canada (IC)	105
Japan	105
ANATEL (Brazil) certification	105

United States (FCC)

The XBee/XBee-PRO S1 802.15.4 (Legacy)s comply with Part 15 of the FCC rules and regulations. Compliance with the labeling requirements, FCC notices and antenna usage guidelines is required.

To fulfill FCC Certification, the OEM must comply with the following regulations:

1. The system integrator must ensure that the text on the external label provided with this device is placed on the outside of the final product.
2. RF Modules may only be used with antennas that have been tested and approved for use with the modules. See [FCC-approved antennas \(2.4 GHz\)](#).

OEM labeling requirements



WARNING! As an Original Equipment Manufacturer (OEM) you must ensure that FCC labeling requirements are met. You must include a clearly visible label on the outside of the final product enclosure that displays the following content:

Required FCC Label for OEM products containing the XBee/XBee-PRO RF Module

Contains FCC ID: OUR-XBEE/OUR-XBEEPRO

This device complies with Part 15 of the FCC Rules. Operation is subject to the following two conditions: (1.) this device may not cause harmful interference and (2.) this device must accept any interference received, including interference that may cause undesired operation.

Note The FCC ID for the XBee is “OUR-XBEE”. The FCC ID for the XBee-PRO is “OUR-XBEEPRO”.

FCC notices

IMPORTANT: The XBee and XBee-PRO RF Modules have been certified by the FCC for use with other products without any further certification (as per FCC section 2.1091). Modifications not expressly approved by Digi could void the user's authority to operate the equipment.

IMPORTANT: OEMs must test final product to comply with unintentional radiators (FCC section 15.107 & 15.109) before declaring compliance of their final product to Part 15 of the FCC Rules.

IMPORTANT: The RF module has been certified for remote and base radio applications. If the module will be used for portable applications, the device must undergo SAR testing.

This equipment has been tested and found to comply with the limits for a Class B digital device, pursuant to Part 15 of the FCC Rules. These limits are designed to provide reasonable protection against harmful interference in a residential installation. This equipment generates, uses and can radiate radio frequency energy and, if not installed and used in accordance with the instructions, may cause harmful interference to radio communications. However, there is no guarantee that interference will not occur in a particular installation.

If this equipment does cause harmful interference to radio or television reception, which can be determined by turning the equipment off and on, the user is encouraged to try to correct the interference by one or more of the following measures: Re-orient or relocate the receiving antenna, Increase the separation between the equipment and receiver, Connect equipment and receiver to outlets on different circuits, or Consult the dealer or an experienced radio/TV technician for help.

FCC-approved antennas (2.4 GHz)

XBee/XBee-PRO RF Modules can be installed using antennas and cables constructed with standard connectors (Type-N, SMA, TNC, etc.) if the installation is performed professionally and according to FCC guidelines. For installations not performed by a professional, non-standard connectors (RPSMA, RPTNC, etc) must be used.

The modules are FCC-approved for fixed base station and mobile applications on channels 0x0B - 0x1A (XBee) and 0x0C - 0x17 (XBee-PRO). If the antenna is mounted at least 20cm (8 in.) from nearby persons, the application is considered a mobile application. Antennas not listed in the table must be tested to comply with FCC Section 15.203 (Unique Antenna Connectors) and Section 15.247 (Emissions).

XBee RF Modules (1 mW): XBee Modules have been tested and approved for use with the antennas listed in the first and second tables below (cable loss is required as shown).

XBee-PRO RF Modules (60 mW): XBee-PRO Modules have been tested and approved for use with the antennas listed in the first and third tables below (cable loss is required as shown).

The antennas in the following tables have been approved for use with this module. Digi does not carry all of these antenna variants. Contact Digi Sales for available antennas.

XBee/XBee-PRO RF Module common antennas

The following table shows the antennas approved for use with the XBee/XBee-PRO RF Modules. Cable loss is not required as shown in the table.

All antenna part numbers followed by an asterisk (*) are not available from Digi. Consult with an antenna manufacturer for an equivalent option.

Part number	Type (description)	Gain	Application ¹	Min. separation
A24-HASM-450	Dipole (half-wave articulated RPSMA - 4.5")	2.1 dBi	Fixed/Mobile	20 cm
A24-HABSM*	Dipole (articulated RPSMA)	2.1 dBi	Fixed	20 cm
A24-HABUF-P5I	Dipole (half-wave articulated bulkhead mount U.FL. w/ 5" pigtail)	2.1 dBi	Fixed	20 cm
A24-HASM-525	Dipole (half-wave articulated RPSMA - 5.25")	2.1 dBi	Fixed/Mobile	20 cm
A24-QI	Monopole (integrated whip)	1.5 dBi	Fixed	20 cm
A24-C1	Surface-mount	-1.5 dBi	Fixed/Mobile	20 cm
29000430	Embedded PCB antenna	-0.5 dBi	Fixed/Mobile	20 cm

¹ If you are using the RF module in a portable application (For example, if the module is used in a handheld device and the antenna is less than 20cm from the human body when the device is operation):

The integrator is responsible for passing additional SAR (Specific Absorption Rate) testing based on FCC rules 2.1091 and FCC Guidelines for Human Exposure to Radio Frequency Electromagnetic Fields, OET Bulletin and Supplement C. The testing results will be submitted to the FCC for approval prior to selling the integrated unit. The required SAR testing measures emissions from the module and how they affect the person.

XBee/XBee-PRO S1 802.15.4 (Legacy) antennas

The following table shows the antennas approved for use with the XBee/XBee-PRO S1 802.15.4 (Legacy). Cable loss is required as shown in the table.

Part number	Type (description)	Gain	Application ¹	Min. separation	Required cable-loss
Yagi class antennas					
A24-Y4NF	Yagi (4-element)	6.0 dBi	Fixed	2 m	-
A24-Y6NF	Yagi (6-element)	8.8 dBi	Fixed	2 m	1.7 dB
A24-Y7NF	Yagi (7-element)	9.0 dBi	Fixed	2 m	1.9 dB
A24-Y9NF	Yagi (9-element)	10.0 dBi	Fixed	2 m	2.9 dB
A24-Y10NF	Yagi (10-element)	11.0 dBi	Fixed	2 m	3.9 dB
A24-Y12NF	Yagi (12-element)	12.0 dBi	Fixed	2 m	4.9 dB
A24-Y13NF	Yagi (13-element)	12.0 dBi	Fixed	2 m	4.9 dB
A24-Y15NF	Yagi (15-element)	12.5 dBi	Fixed	2 m	5.4 dB
A24-Y16NF	Yagi (16-element)	13.5 dBi	Fixed	2 m	6.4 dB
A24-Y16RM	Yagi (16-element, RPSMA connector)	13.5 dBi	Fixed	2 m	6.4 dB
A24-Y18NF	Yagi (18-element)	15.0 dBi	Fixed	2 m	7.9 dB
Omni-directional class antennas					
A24-F2NF	Omni-directional (Fiberglass base station)	2.1 dBi	Fixed/mobile	20 m	-
A24-F3NF	Omni-directional (Fiberglass base station)	3.0 dBi	Fixed/mobile	20 m	-
A24-F5NF	Omni-directional (Fiberglass base station)	5.0 dBi	Fixed/mobile	20 m	-
A24-F8NF	Omni-directional (Fiberglass base station)	8.0 dBi	Fixed	2 m	-

Part number	Type (description)	Gain	Application ¹	Min. separation	Required cable-loss
A24-F9NF	Omni-directional (Fiberglass base station)	9.5 dBi	Fixed	2 m	0.2 dB
A24-F10NF	Omni-directional (Fiberglass base station)	10.0 dBi	Fixed	2 m	0.7 dB
A24-F12NF	Omni-directional (Fiberglass base station)	12.0 dBi	Fixed	2 m	2.7 dB
A24-F15NF	Omni-directional (Fiberglass base station)	15.0 dBi	Fixed	2 m	5.7 dB
A24-W7NF	Omni-directional (base station)	7.2 dBi	Fixed	2 m	-
A24-M7NF	Omni-directional (mag-mount base station)	7.2 dBi	Fixed	2 m	-
Panel class antennas					
A24-P8SF	Flat panel	8.5 dBi	Fixed	2 m	1.5 dB
A24-P8NF	Flat panel	8.5 dBi	Fixed	2 m	1.5 dB
A24-P13NF	Flat panel	13.0 dBi	Fixed	2 m	6 dB
A24-P14NF	Flat panel	14.0 dBi	Fixed	2 m	7 dB
A24-P15NF	Flat panel	15.0 dBi	Fixed	2 m	8 dB
A24-P16NF	Flat panel	16.0 dBi	Fixed	2 m	9 dB

¹ If you are using the RF module in a portable application (For example, if the module is used in a handheld device and the antenna is less than 20 cm from the human body when the device is operation):

The integrator is responsible for passing additional SAR (Specific Absorption Rate) testing based on FCC rules 2.1091 and FCC Guidelines for Human Exposure to Radio Frequency Electromagnetic Fields, OET Bulletin and Supplement C. The testing results will be submitted to the FCC for approval prior to selling the integrated unit. The required SAR testing measures emissions from the module and how they affect the person.

XBee-PRO RF Module antennas

The following table shows the antennas approved for use with the XBee-PRO RF Module. Cable loss is required as shown in the table.

Part number	Type	Gain	Application ¹	Min. separation	Required cable-loss
Yagi class antennas					
A24-Y4NF	Yagi (4-element)	6.0 dBi	Fixed	2 m	8.1 dB
A24-Y6NF	Yagi (6-element)	8.8 dBi	Fixed	2 m	10.9 dB
A24-Y7NF	Yagi (7-element)	9.0 dBi	Fixed	2 m	11.1 dB
A24-Y9NF	Yagi (9-element)	10.0 dBi	Fixed	2 m	12.1 dB
A24-Y10NF	Yagi (10-element)	11.0 dBi	Fixed	2 m	13.1 dB
A24-Y12NF	Yagi (12-element)	12.0 dBi	Fixed	2 m	14.1 dB
A24-Y13NF	Yagi (13-element)	12.0 dBi	Fixed	2 m	14.1 dB
A24-Y15NF	Yagi (15-element)	12.5 dBi	Fixed	2 m	14.6 dB
A24-Y16NF	Yagi (16-element)	13.5 dBi	Fixed	2 m	15.6 dB
A24-Y16RM	Yagi (16-element, RPSMA connector)	13.5 dBi	Fixed	2 m	15.6 dB
A24-Y18NF	Yagi (18-element)	15.0 dBi	Fixed	2 m	17.1 dB
Omni-directional class antennas					
A24-F2NF	Omni-directional (fiberglass base station)	2.1 dBi	Fixed/mobile	20 m	4.2 dB
A24-F3NF	Omni-directional (fiberglass base station)	3.0 dBi	Fixed/mobile	20 m	5.1 dB
A24-F5NF	Omni-directional (fiberglass base station)	5.0 dBi	Fixed/mobile	20 m	7.1 dB
A24-F8NF	Omni-directional (fiberglass base station)	8.0 dBi	Fixed	2 m	10.1 dB
A24-F9NF	Omni-directional (fiberglass base station)	9.5 dBi	Fixed	2 m	11.6 dB

Part number	Type	Gain	Application ¹	Min. separation	Required cable-loss
A24-F10NF	Omni-directional (fiberglass base station)	10.0 dBi	Fixed	2 m	12.1 dB
A24-F12NF	Omni-directional (fiberglass base station)	12.0 dBi	Fixed	2 m	14.1 dB
A24-F15NF	Omni-directional (fiberglass base station)	15.0 dBi	Fixed	2 m	17.1 dB
A24-W7NF	Omni-directional (base station)	7.2 dBi	Fixed	2 m	9.3 dB
A24-M7NF	Omni-directional (mag-mount base station)	7.2 dBi	Fixed	2 m	9.3 dB
Panel class antennas					
A24-P8SF	Flat panel	8.5 dBi	Fixed	2 m	8.6 dB
A24-P8NF	Flat panel	8.5 dBi	Fixed	2 m	8.6 dB
A24-P13NF	Flat panel	13.0 dBi	Fixed	2 m	13.1 dB
A24-P14NF	Flat panel	14.0 dBi	Fixed	2 m	14.1 dB
A24-P15NF	Flat panel	15.0 dBi	Fixed	2 m	15.1 dB
A24-P16NF	Flat panel	16.0 dBi	Fixed	2 m	16.1 dB
A24-P19NF	Flat panel	19.0 dBi	Fixed	2 m	19.1 dB
Waveguide class antennas					
RSM	Waveguide	7.1 dBi	Fixed	2 m	1.5 dB
Helical class antenna					
A24-H3UF	Helical	3.0 dBi	Fixed	20 m	0 dB

¹ If you are using the RF module in a portable application (For example, if the module is used in a handheld device and the antenna is less than 20 cm from the human body when the device is operation):

The integrator is responsible for passing additional SAR (Specific Absorption Rate) testing based on FCC rules 2.1091 and FCC Guidelines for Human Exposure to Radio Frequency Electromagnetic Fields, OET Bulletin and Supplement C. The testing results will be submitted to the FCC for approval prior to selling the integrated unit. The required SAR testing measures emissions from the module and how they affect the person.

RF exposure

If you are an integrating the XBee into another product, you must include the following Caution statement in OEM product manuals to alert users of FCC RF exposure compliance:



CAUTION! To satisfy FCC RF exposure requirements for mobile transmitting devices, a separation distance of 25 cm or more should be maintained between the antenna of this device and persons during device operation. To ensure compliance, operations at closer than this distance are not recommended. The antenna used for this transmitter must not be co-located in conjunction with any other antenna or transmitter.

Europe

The XBee modules (non-PRO and international versions only) have been tested for use in several European countries. For a complete list, refer to www.digi.com.

If the XBee RF Modules are incorporated into a product, the manufacturer must ensure compliance of the final product with articles 3.1a and 3.1b of the R&TTE Directive. A Declaration of Conformity must be issued for each of these standards and kept on file as described in the R&TTE Directive.

Furthermore, the manufacturer must maintain a copy of the XBee user manual documentation and ensure the final product does not exceed the specified power ratings, antenna specifications, and/or installation requirements as specified in the user guide.

OEM labeling requirements

The “CE” marking must be affixed to a visible location on the OEM product. The following figure shows CE labeling requirements.

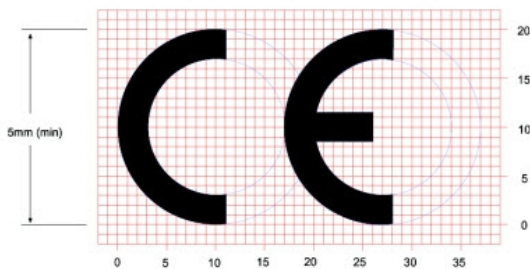

The CE mark shall consist of the initials “CE” taking the following form:

- If the CE marking is reduced or enlarged, the proportions given in the above graduated drawing must be respected.
- The CE marking must have a height of at least 5 mm except where this is not possible on account of the nature of the apparatus.
- The CE marking must be affixed visibly, legibly, and indelibly.

Restrictions

Power Output: When operating in Europe, XBee-PRO 802.15.4 modules must operate at or below a transmit power output level of 10dBm. To transmit at or below 10dBm:

Order the International variant of the XBee-PRO module, which has a maximum transmit output power of 10dBm (@ PL=4).

Important note

Digi does not list the entire set of standards that must be met for each country. Digi customers assume full responsibility for learning and meeting the required guidelines for each country in their distribution market. Refer to the radio regulatory agency in the desired countries of operation for more information.

Declarations of conformity

Digi has issued Declarations of Conformity for the XBee RF Modules concerning emissions, EMC, and safety. For more information, see <http://www.digi.com/resources/certifications>.

Antennas

The following antennas have been tested and approved for use with the XBee/XBee-PRO S1 802.15.4 (Legacy):

- Dipole (2.1 dBi, Omni-directional, Articulated RPSMA, Digi part number A24-HABSM)
- PCB Antenna (0.0 dBi)
- Monopole Whip (1.5 dBi)

Canada (IC)**Labeling requirements**

Labeling requirements for Industry Canada are similar to those of the FCC. A clearly visible label on the outside of the final product enclosure must display the following text:

Contains Model XBee Radio, IC: 4214A-XBEE

Contains Model XBee-PRO Radio, IC: 4214A-XBEEPRO

The integrator is responsible for its product to comply with IC ICES-003 and FCC Part 15, Sub. B - Unintentional Radiators. ICES-003 is the same as FCC Part 15 Sub. B and Industry Canada accepts Industry Canada RSS-247 or CISPR 22 test report for compliance with ICES-003.

Japan

In order to use the XBee-PRO in Japan, you must order the International version. The International XBee-PRO RF Modules are limited to a transmit power output of 10 dBm (10 mW).

Labeling requirements

A clearly visible label on the outside of the final product enclosure must display the following text:

R201WW07215214 (XBee)

R201WW08215111 (XBee-PRO)

ANATEL (Brazil) certification

The XBee RF modules with 802.15.4 or DigiMesh firmware (models noted in the following conformity information) comply with Brazil ANATEL standards in Resolution No. 506. The following information is required in the user manual for the product containing the radio and on the product containing the radio (in Portuguese):

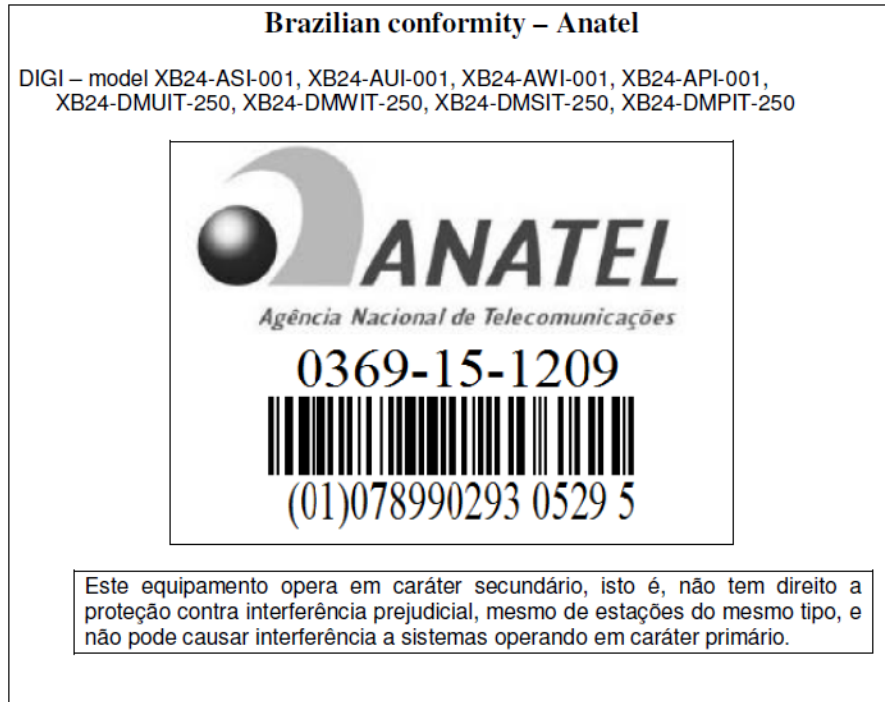

The XBee-PRO RF modules with 802.15.4 or DigiMesh firmware (models noted in conformity information below) comply with Brazil ANATEL standards in Resolution No. 506. The following information is required in the user manual for the product containing the radio and on the product containing the radio (in Portuguese):

Brazilian conformity – Anatel

DIGI models XBP24-ASI-001, XBP24-AUI-001, XBP24-AWI-001, XBP24-API-001,
XBP24-DMUIT-250, XBP24-DMWIT-250, XBP24-DMSIT-250, XBP24-DMPIT-250



Este equipamento opera em caráter secundário, isto é, não tem direito a proteção contra interferência prejudicial, mesmo de estações do mesmo tipo, e não pode causar interferência a sistemas operando em caráter primário.