

HIGH RIPPLE-REJECTION LOW DROPOUT HIGH OUTPUT CURRENT CMOS VOLTAGE REGULATOR

The S-1155 Series, developed by using CMOS technology, is a positive voltage regulator with a super low dropout voltage, high-accuracy output voltage and low current consumption.

The S-1155 Series provides the very low dropout voltage and the large output current due to the built-in transistor with low on-resistance. The S-1155 Series includes an overcurrent protection circuit that prevents the load current from exceeding the current capacitance of the output transistor, a thermal shutdown circuit that prevents damage due to overheating, and an inrush current limit circuit to limit the excessive inrush current generated at power-on.

The ON/OFF circuit ensures longer battery life. Compared with the voltage regulators using the conventional CMOS technology, a large variety of capacitors are available, including small ceramic capacitors

The small package SOT-89-5 realizes high-density mounting.

■ Features

- Output voltage: 1.0 V to 5.0 V, selectable in 0.05 V step
- Input voltage: 1.5 V to 5.5 V
- Output voltage accuracy: $\pm 1.0\%$ (1.0 V to 1.45 V output product: ± 15 mV)
- Dropout voltage: 70 mV typ. (3.0 V output product, $I_{OUT} = 200$ mA)
- Current consumption: During operation: 70 μ A typ., 90 μ A max. (3.0 V output product)
During power-off: 0.1 μ A typ., 1.0 μ A max.
- Output current: Possible to output 500 mA (3.0 V output product, $V_{IN} \geq V_{OUT(S)} + 1.0$ V)*1
- Input and output capacitors: A ceramic capacitor of 4.7 μ F or more can be used.
- Ripple rejection: 70 dB typ. (1.0 V output product, $f = 1.0$ kHz)
- Built-in overcurrent protection circuit: Limits overcurrent of output transistor.
- Built-in thermal shutdown circuit: Prevents damage caused by heat.
- Built-in inrush current limit circuit: Limits excessive inrush current at power-on.
- Built-in ON/OFF circuit: Ensures long battery life.
- Operation temperature range: $T_a = -40^\circ\text{C}$ to $+85^\circ\text{C}$
- Lead-free, Sn 100%, halogen-free*2

*1. Attention should be paid to the power dissipation of the package when the output current is large.

*2. Refer to "■ Product Name Structure" for details.

■ Applications

- Constant-voltage power supply for battery-powered device
- Constant-voltage power supply for TV, notebook PC and home electric appliance
- Constant-voltage power supply for portable equipment

■ Package

- SOT-89-5

■ Block Diagram

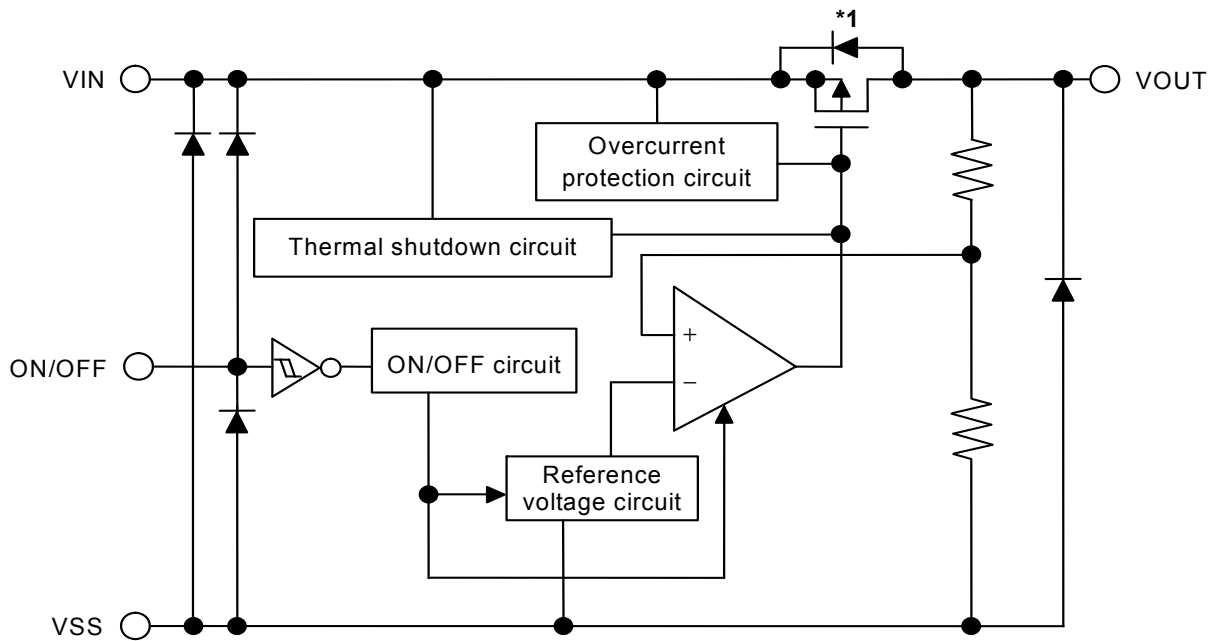

*1. Parasitic diode

Figure 1

■ **Product Name Structure**

Users can select the product type, output voltage, and package type for the S-1155 Series. Refer to “1. **Product name**” regarding the contents of product name, “2. **Package**” regarding the package drawings and “3. **Product name list**” regarding details of product name.

1. **Product name**

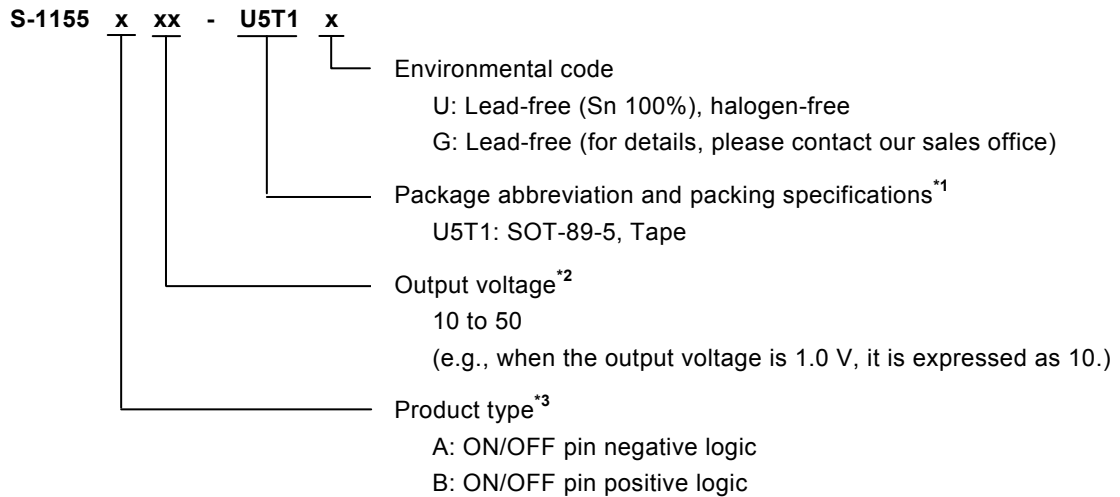

- *1. Refer to the tape drawing.
- *2. If you request the product which has 0.05 step, contact our sales office.
- *3. Refer to “3. **ON/OFF pin**” in “■ **Operation**”.

2. **Package**

Package Name	Drawing Code		
	Package	Tape	Reel
SOT-89-5	UP005-A-P-SD	UP005-A-C-SD	UP005-A-R-SD

3. Product name list

Table 1

Output Voltage	SOT-89-5
1.0 V \pm 15 mV	S-1155B10-U5T1x
1.1 V \pm 15 mV	S-1155B11-U5T1x
1.2 V \pm 15 mV	S-1155B12-U5T1x
1.3 V \pm 15 mV	S-1155B13-U5T1x
1.4 V \pm 15 mV	S-1155B14-U5T1x
1.5 V \pm 1.0%	S-1155B15-U5T1x
1.6 V \pm 1.0%	S-1155B16-U5T1x
1.7 V \pm 1.0%	S-1155B17-U5T1x
1.8 V \pm 1.0%	S-1155B18-U5T1x
1.85 V \pm 1.0%	S-1155B1J-U5T1x
1.9 V \pm 1.0%	S-1155B19-U5T1x
2.0 V \pm 1.0%	S-1155B20-U5T1x
2.1 V \pm 1.0%	S-1155B21-U5T1x
2.2 V \pm 1.0%	S-1155B22-U5T1x
2.3 V \pm 1.0%	S-1155B23-U5T1x
2.4 V \pm 1.0%	S-1155B24-U5T1x
2.5 V \pm 1.0%	S-1155B25-U5T1x
2.6 V \pm 1.0%	S-1155B26-U5T1x
2.7 V \pm 1.0%	S-1155B27-U5T1x
2.8 V \pm 1.0%	S-1155B28-U5T1x
2.85 V \pm 1.0%	S-1155B2J-U5T1x
2.9 V \pm 1.0%	S-1155B29-U5T1x
3.0 V \pm 1.0%	S-1155B30-U5T1x
3.1 V \pm 1.0%	S-1155B31-U5T1x
3.2 V \pm 1.0%	S-1155B32-U5T1x
3.3 V \pm 1.0%	S-1155B33-U5T1x
3.4 V \pm 1.0%	S-1155B34-U5T1x
3.5 V \pm 1.0%	S-1155B35-U5T1x
3.6 V \pm 1.0%	S-1155B36-U5T1x
3.7 V \pm 1.0%	S-1155B37-U5T1x
3.8 V \pm 1.0%	S-1155B38-U5T1x
3.9 V \pm 1.0%	S-1155B39-U5T1x
4.0 V \pm 1.0%	S-1155B40-U5T1x
4.1 V \pm 1.0%	S-1155B41-U5T1x
4.2 V \pm 1.0%	S-1155B42-U5T1x
4.3 V \pm 1.0%	S-1155B43-U5T1x
4.4 V \pm 1.0%	S-1155B44-U5T1x
4.5 V \pm 1.0%	S-1155B45-U5T1x
4.6 V \pm 1.0%	S-1155B46-U5T1x
4.7 V \pm 1.0%	S-1155B47-U5T1x
4.8 V \pm 1.0%	S-1155B48-U5T1x
4.9 V \pm 1.0%	S-1155B49-U5T1x
5.0 V \pm 1.0%	S-1155B50-U5T1x

Remark 1. Please contact our sales office for products with an output voltage other than those specified above or type A products.

2. x: G or U

3. Please select products of environmental code = U for Sn 100%, halogen-free products.

■ Pin Configuration

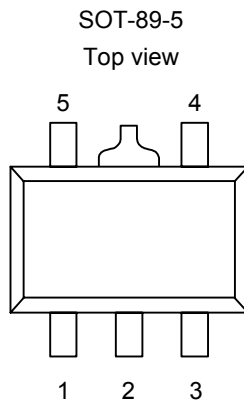

Figure 2

Table 2

Pin No.	Symbol	Description
1	ON/OFF	ON/OFF pin
2	VSS	GND pin
3	NC*1	No connection
4	VIN	Input voltage pin
5	VOUT	Output voltage pin

*1. The NC pin is electrically open.
The NC pin can be connected to VIN pin or VSS pin.

■ **Absolute Maximum Ratings**

Table 3

(Ta = 25°C unless otherwise specified)

Item	Symbol	Absolute Maximum Rating	Unit
Input voltage	V _{IN}	V _{SS} – 0.3 to V _{SS} + 6	V
	V _{ON/OFF}	V _{SS} – 0.3 to V _{IN} + 0.3	V
Output voltage	V _{OUT}	V _{SS} – 0.3 to V _{IN} + 0.3	V
Power dissipation	P _D	1000*1	mW
Operation ambient temperature	T _{opr}	–40 to +85	°C
Storage temperature	T _{stg}	–40 to +125	°C

*1. When mounted on board

[Mounted board]

- (1) Board size : 114.3 mm × 76.2 mm × t1.6 mm
- (2) Name : JEDEC STANDARD51-7

Caution The absolute maximum ratings are rated values exceeding which the product could suffer physical damage. These values must therefore not be exceeded under any conditions.

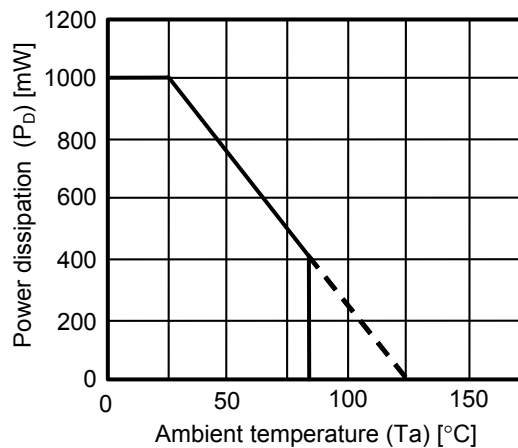

Figure 3 Power Dissipation of Package (When Mounted on Board)

Table 4

Condition	Power Dissipation	Thermal Resistance Value (θ _{j-a})
SOT-89-5 (When mounted on board)	1000 mW	100°C/W

■ Electrical Characteristics

Table 5 (1 / 2)

(Ta = 25°C unless otherwise specified)

Item	Symbol	Condition	Min.	Typ.	Max.	Unit	Test Circuit	
Output voltage*1	V _{OUT(E)}	V _{IN} = V _{OUT(S)} + 1.0 V, I _{OUT} = 100 mA	1.0 V ≤ V _{OUT(S)} < 1.5 V	V _{OUT(S)} − 0.015	V _{OUT(S)}	V _{OUT(S)} + 0.015	V	1
			1.5 V ≤ V _{OUT(S)} ≤ 4.5 V	V _{OUT(S)} × 0.99	V _{OUT(S)}	V _{OUT(S)} × 1.01	V	1
		V _{IN} = 5.5 V, I _{OUT} = 100 mA	4.5 V < V _{OUT(S)} ≤ 5.0 V	V _{OUT(S)} × 0.99	V _{OUT(S)}	V _{OUT(S)} × 1.01	V	1
Output current*2	I _{OUT}	V _{IN} ≥ V _{OUT(S)} + 1.0 V	1.0 V ≤ V _{OUT(S)} ≤ 4.5 V	500*5	–	–	mA	3
		V _{IN} = 5.5 V	4.5 V < V _{OUT(S)} ≤ 5.0 V	500*5	–	–	mA	3
Dropout voltage*3	V _{drop}	I _{OUT} = 200 mA	1.0 V ≤ V _{OUT(S)} < 1.1 V	0.5	0.54	0.58	V	1
			1.1 V ≤ V _{OUT(S)} < 1.2 V	–	0.44	0.48	V	1
			1.2 V ≤ V _{OUT(S)} < 1.3 V	–	0.34	0.38	V	1
			1.3 V ≤ V _{OUT(S)} < 1.4 V	–	0.24	0.28	V	1
			1.4 V ≤ V _{OUT(S)} < 1.5 V	–	0.14	0.18	V	1
			1.5 V ≤ V _{OUT(S)} < 2.6 V	–	0.10	0.15	V	1
			2.6 V ≤ V _{OUT(S)} ≤ 5.0 V	–	0.07	0.10	V	1
Line regulation	$\frac{\Delta V_{OUT1}}{\Delta V_{IN} \cdot V_{OUT}}$	V _{OUT(S)} + 0.5 V ≤ V _{IN} ≤ 5.5 V, I _{OUT} = 100 mA	1.0 V ≤ V _{OUT(S)} < 3.6 V	–	0.05	0.2	%/V	1
			3.6 V ≤ V _{OUT(S)} ≤ 4.8 V	–	2.5	10	mV	1
			4.8 V < V _{OUT(S)} ≤ 5.0 V	–	2.5	10	mV	1
Load regulation	ΔV _{OUT2}	V _{IN} = V _{OUT(S)} + 1.0 V, 1 mA ≤ I _{OUT} ≤ 200 mA	1.0 V ≤ V _{OUT(S)} ≤ 4.5 V	–	15	30	mV	1
		V _{IN} = 5.5 V, 1 mA ≤ I _{OUT} ≤ 200 mA	4.5 V < V _{OUT(S)} ≤ 5.0 V	–	15	30	mV	1
Output voltage temperature coefficient*4	$\frac{\Delta V_{OUT}}{\Delta Ta \cdot V_{OUT}}$	V _{IN} = V _{OUT(S)} + 1.0 V, I _{OUT} = 100 mA, −40°C ≤ Ta ≤ 85°C	1.0 V ≤ V _{OUT(S)} ≤ 4.5 V	–	±130	–	ppm/°C	1
		V _{IN} = 5.5 V, I _{OUT} = 100 mA, −40°C ≤ Ta ≤ 85°C	4.5 V < V _{OUT(S)} ≤ 5.0 V	–	±130	–	ppm/°C	1
Current consumption during operation	I _{SS1}	V _{IN} = V _{OUT(S)} + 1.0 V, ON/OFF pin = ON, no load, 1.0 V ≤ V _{OUT(S)} < 1.8 V		–	90	110	μA	2
		V _{IN} = V _{OUT(S)} + 1.0 V, ON/OFF pin = ON, no load, 1.8 V ≤ V _{OUT(S)} ≤ 4.5 V		–	70	90	μA	2
		V _{IN} = 5.5 V, ON/OFF pin = ON, no load, 4.5 V < V _{OUT(S)} ≤ 5.0 V		–	70	90	μA	2
Current consumption during power-off	I _{SS2}	V _{IN} = V _{OUT(S)} + 1.0 V, ON/OFF pin = OFF, no load	1.0 V ≤ V _{OUT(S)} ≤ 4.5 V	–	0.1	1.0	μA	2
		V _{IN} = 5.5 V, ON/OFF pin = OFF, no load	4.5 V < V _{OUT(S)} ≤ 5.0 V	–	0.1	1.0	μA	2
Input voltage	V _{IN}	–	1.5	–	5.5	V	–	

Table 5 (2 / 2)

(Ta = 25°C unless otherwise specified)

Item	Symbol	Condition	Min.	Typ.	Max.	Unit	Test Circuit	
ON/OFF pin input voltage "H"	V _{SH}	V _{IN} = V _{OUT(S)} + 1.0 V, R _L = 1.0 kΩ, determined by V _{OUT} output level 1.0 V ≤ V _{OUT(S)} ≤ 4.5 V	1.0	–	–	V	4	
		V _{IN} = 5.5 V, R _L = 1.0 kΩ, determined by V _{OUT} output level 4.5 V < V _{OUT(S)} ≤ 5.0 V	1.0	–	–	V	4	
ON/OFF pin input voltage "L"	V _{SL}	V _{IN} = V _{OUT(S)} + 1.0 V, R _L = 1.0 kΩ, determined by V _{OUT} output level 1.0 V ≤ V _{OUT(S)} ≤ 4.5 V	–	–	0.3	V	4	
		V _{IN} = 5.5 V, R _L = 1.0 kΩ, determined by V _{OUT} output level 4.5 V < V _{OUT(S)} ≤ 5.0 V	–	–	0.3	V	4	
ON/OFF pin input current "H"	I _{SH}	V _{IN} = 5.5 V, V _{ON/OFF} = 5.5 V	–0.1	–	0.1	μA	4	
ON/OFF pin input current "L"	I _{SL}	V _{IN} = 5.5 V, V _{ON/OFF} = 0 V	–0.1	–	0.1	μA	4	
Ripple rejection	RR	V _{IN} = V _{OUT(S)} + 1.0 V, f = 1 kHz, ΔV _{rip} = 0.5 V _{rms} , I _{OUT} = 100 mA	1.0 V ≤ V _{OUT(S)} < 1.2 V	–	70	–	dB	5
			1.2 V ≤ V _{OUT(S)} ≤ 3.0 V	–	65	–	dB	5
			3.0 V < V _{OUT(S)} ≤ 4.5 V	–	60	–	dB	5
		V _{IN} = 5.5 V, f = 1 kHz, ΔV _{rip} = 0.5 V _{rms} , I _{OUT} = 100 mA	4.5 V < V _{OUT(S)} ≤ 5.0 V	–	60	–	dB	5
Short-circuit current	I _{SHORT}	V _{IN} = V _{OUT(S)} + 1.0 V, ON/OFF pin = ON, V _{OUT} = 0 V 1.0 V ≤ V _{OUT(S)} ≤ 4.5 V	–	200	–	mA	3	
		V _{IN} = 5.5 V, ON/OFF pin = ON, V _{OUT} = 0 V 4.5 V < V _{OUT(S)} ≤ 5.0 V	–	200	–	mA	3	
Thermal shutdown detection temperature	T _{SD}	Junction temperature	–	150	–	°C	–	
Thermal shutdown release temperature	T _{SR}	Junction temperature	–	120	–	°C	–	

- *1. V_{OUT(S)}: Set output voltage
V_{OUT(E)}: Actual output voltage
Output voltage when fixing I_{OUT} (= 100 mA) and inputting V_{OUT(S)} + 1.0 V or 5.5 V
- *2. The output current at which the output voltage becomes 95% of V_{OUT(E)} after gradually increasing the output current.
- *3. V_{drop} = V_{IN1} – (V_{OUT3} × 0.98)
V_{OUT3} is the output voltage when V_{IN} = V_{OUT(S)} + 1.0 V or 5.5 V, and I_{OUT} = 200 mA.
V_{IN1} is the input voltage at which the output voltage becomes 98% of V_{OUT3} after gradually decreasing the input voltage.
- *4. A change in the temperature of the output voltage [mV/°C] is calculated using the following equation.

$$\frac{\Delta V_{OUT}}{\Delta T_a} \text{ [mV/}^\circ\text{C]}^*1 = V_{OUT(S)} \text{ [V]}^*2 \times \frac{\Delta V_{OUT}}{\Delta T_a \bullet V_{OUT}} \text{ [ppm/}^\circ\text{C]}^*3 \div 1000$$
 - *1. Change in temperature of output voltage
 - *2. Set output voltage
 - *3. Output voltage temperature coefficient
- *5. The output current can be at least this value.
Due to restrictions on the package power dissipation, this value may not be satisfied. Attention should be paid to the power dissipation of the package when the output current is large.
This specification is guaranteed by design.

■ Test Circuits

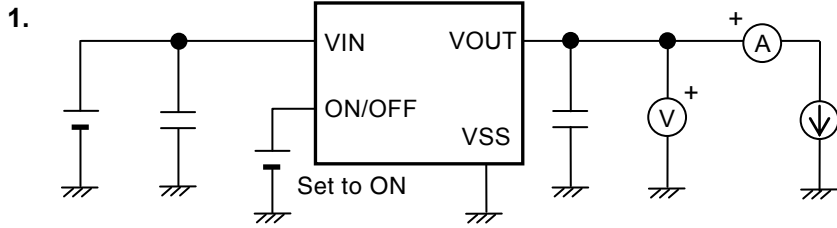

Figure 4

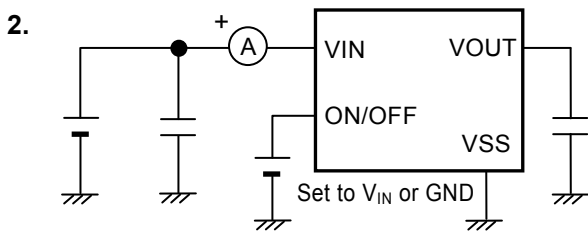

Figure 5

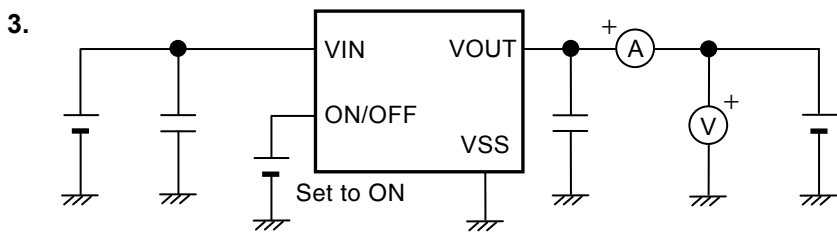

Figure 6

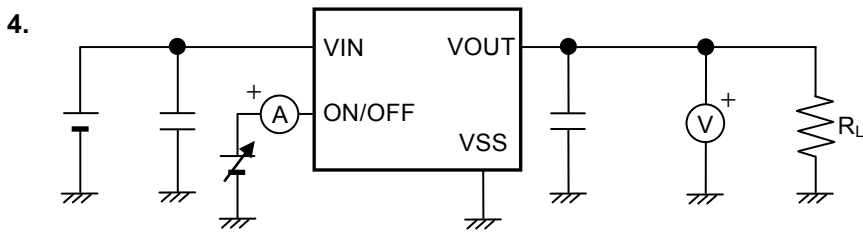

Figure 7

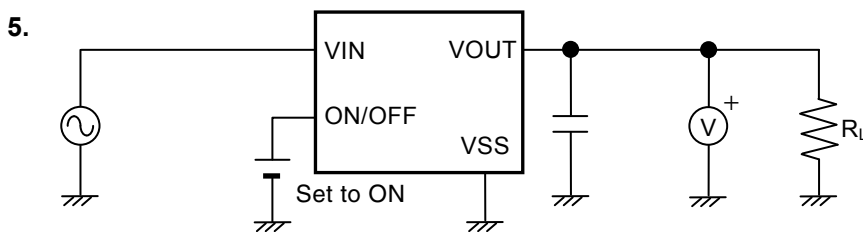
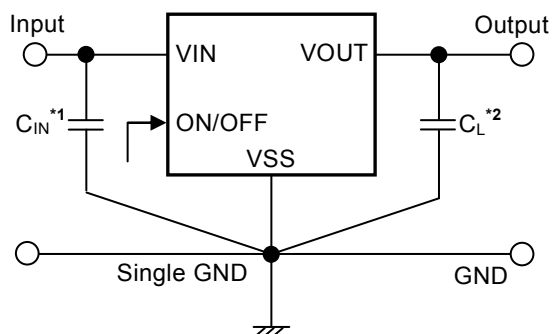

Figure 8

■ Standard Circuit



*1. C_{IN} is a capacitor for stabilizing the input.

*2. A ceramic capacitor of 4.7 μF or more can be used as C_L .

Figure 9

Caution The above connection diagram and constant will not guarantee successful operation. Perform thorough evaluation using the actual application to set the constant.

■ Condition of Application

Input capacitor (C_{IN}): 4.7 μF or more

Output capacitor (C_L): 4.7 μF or more

- Caution**
1. Set input capacitor (C_{IN}) and output capacitor (C_L) as $C_{IN} = C_L$.
 2. Generally a series regulator may cause oscillation, depending on the selection of external parts. Confirm that no oscillation occurs in the application for which the above capacitors are used.

■ Selection of Input and Output Capacitors (C_{IN} , C_L)

The S-1155 Series requires an output capacitor between the VOUT pin and the VSS pin for phase compensation. Operation is stabilized by a ceramic capacitor with an output capacitance of 4.7 μF or more over the entire temperature range. When using an OS capacitor, a tantalum capacitor, or an aluminum electrolytic capacitor, the capacitance must be 4.7 μF or more.

The values of output overshoot and undershoot, which are transient response characteristics, vary depending on the value of output capacitor.

The required value of capacitance for the input capacitor differs depending on the application.

Set the value for input capacitor (C_{IN}) and output capacitor (C_L) as follows.

$$C_{IN} \geq 4.7 \mu\text{F}$$

$$C_L \geq 4.7 \mu\text{F}$$

$$C_{IN} = C_L$$

Caution The S-1155 Series may oscillate if setting the value as $C_{IN} \geq 4.7 \mu\text{F}$, $C_L \geq 4.7 \mu\text{F}$, $C_{IN} < C_L$. Define the values by sufficient evaluation including the temperature characteristics under the usage condition.

■ Explanation of Terms

1. Low dropout voltage regulator

This voltage regulator has the low dropout voltage due to its built-in low on-resistance transistor.

2. Output voltage (V_{OUT})

The accuracy of the output voltage is ensured at $\pm 1.0\%$ or $\pm 15 \text{ mV}^2$ under the specified conditions of fixed input voltage*1, fixed output current, and fixed temperature.

*1. Differs depending on the product.

*2. When $V_{OUT} < 1.5 \text{ V}$: $\pm 15 \text{ mV}$, when $1.5 \text{ V} \leq V_{OUT}$: $\pm 1.0\%$

Caution If the above conditions change, the output voltage value may vary and exceed the accuracy range of the output voltage. Refer to “■ Electrical Characteristics” and “■ Characteristics (Typical Data)” for details.

3. Line regulation $\left(\frac{\Delta V_{OUT1}}{\Delta V_{IN} \bullet V_{OUT}} \right)$

Indicates the dependency of the output voltage against the input voltage. That is, the value shows how much the output voltage changes due to a change in the input voltage after fixing output current constant.

4. Load regulation (ΔV_{OUT2})

Indicates the dependency of the output voltage against the output current. That is, the value shows how much the output voltage changes due to a change in the output current after fixing output current constant.

5. Dropout voltage (V_{drop})

Indicates the difference between input voltage (V_{IN1}) and the output voltage when; decreasing input voltage (V_{IN}) gradually until the output voltage has dropped out to the value of 98% of output voltage (V_{OUT3}), which is at $V_{IN} = V_{OUT(S)} + 1.0 \text{ V}$ or 5.5 V .

$$V_{drop} = V_{IN1} - (V_{OUT3} \times 0.98)$$

6. Output voltage temperature coefficient $\left(\frac{\Delta V_{OUT}}{\Delta T_a \bullet V_{OUT}}\right)$

The shaded area in **Figure 10** is the range where V_{OUT} varies in the operation temperature range when the output voltage temperature coefficient is ± 130 ppm/ $^{\circ}\text{C}$.

Example of S-1155B30 typ. product

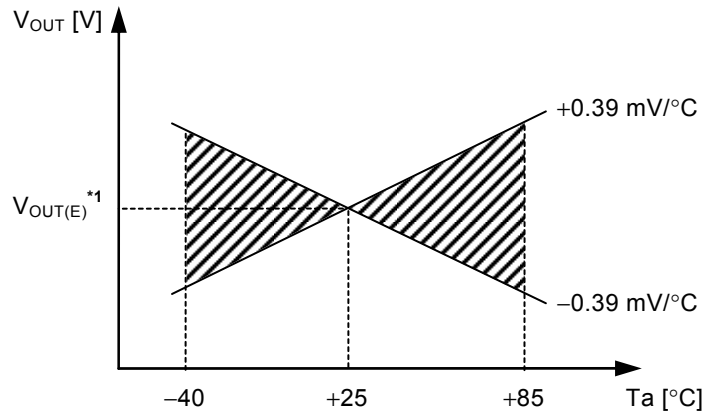

*1. $V_{OUT(E)}$ is the value of the output voltage measured at $T_a = +25^{\circ}\text{C}$.

Figure 10

A change in the temperature of the output voltage [$\text{mV}/^{\circ}\text{C}$] is calculated using the following equation.

$$\frac{\Delta V_{OUT}}{\Delta T_a} [\text{mV}/^{\circ}\text{C}]^{*1} = V_{OUT(S)} [\text{V}]^{*2} \times \frac{\Delta V_{OUT}}{\Delta T_a \bullet V_{OUT}} [\text{ppm}/^{\circ}\text{C}]^{*3} \div 1000$$

- *1. Change in temperature of output voltage
- *2. Set output voltage
- *3. Output voltage temperature coefficient

■ Operation

1. Basic operation

Figure 11 shows the block diagram of the S-1155 Series.

The error amplifier compares the reference voltage (V_{ref}) with feedback voltage (V_{fb}), which is the output voltage resistance-divided by feedback resistors (R_s and R_f). It supplies the gate voltage necessary to maintain the constant output voltage which is not influenced by the input voltage and temperature change, to the output transistor.

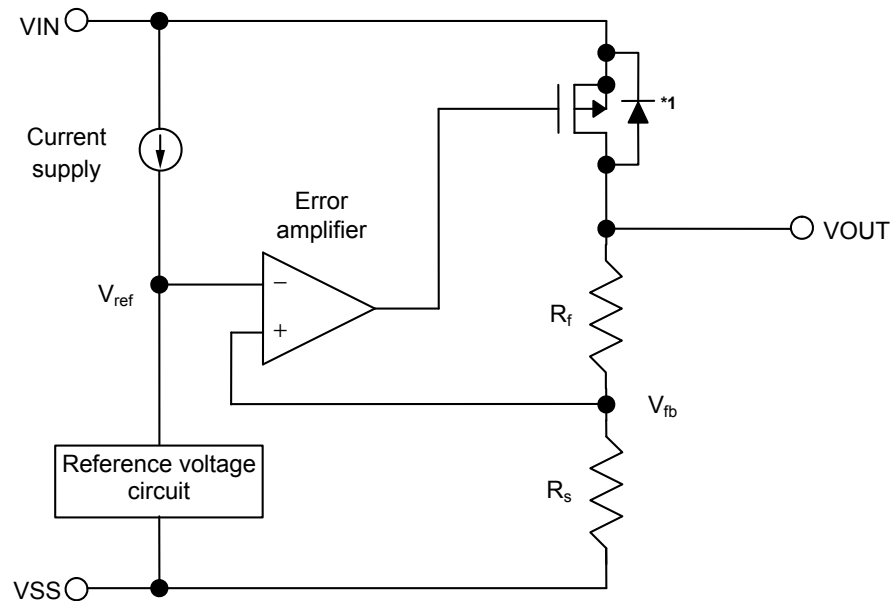

*1. Parasitic diode

Figure 11

2. Output transistor

In the S-1155 Series, a low on-resistance P-channel MOS FET is used as the output transistor.

Be sure that V_{OUT} does not exceed $V_{IN} + 0.3$ V to prevent the voltage regulator from being damaged due to reverse current flowing from the V_{OUT} pin through a parasitic diode to the V_{IN} pin, when the potential of V_{OUT} became higher than V_{IN} .

3. ON/OFF pin

This pin starts and stops the regulator.

When the ON/OFF pin is set to OFF level, the entire internal circuit stops operating, and the built-in P-channel MOS FET output transistor between the VIN pin and the VOUT pin is turned off, reducing current consumption significantly. The VOUT pin is set to the VSS level by the internal dividing resistor of several hundred kΩ between the VOUT pin and the VSS pin.

Note that the current consumption increases when a voltage of 0.3 V to 1.0 V is applied to the ON/OFF pin.

The ON/OFF pin is configured as shown in **Figure 12**. Since the ON/OFF pin is neither pulled down nor pulled up internally, do not use it in the floating status. When not using the ON/OFF pin, connect it to the VSS pin in the product A type, and connect it to the VIN pin in B type.

Table 6

Product Type	ON/OFF Pin	Internal Circuit	VOUT Pin Voltage	Current Consumption
A	"L": ON	Operate	Set value	I _{SS1}
A	"H": OFF	Stop	V _{SS} level	I _{SS2}
B	"L": OFF	Stop	V _{SS} level	I _{SS2}
B	"H": ON	Operate	Set value	I _{SS1}

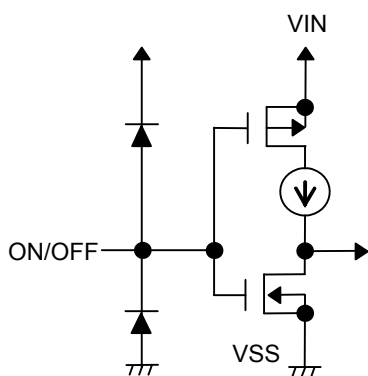

Figure 12

4. Overcurrent protection circuit

The S-1155 Series includes an overcurrent protection circuit having the characteristics shown in "1. Output Voltage vs. Output Current (When load current increases) (Ta = 25°C)" in "■ Characteristics (Typical Data)", in order to protect the output transistor against an excessive output current and short circuiting between the VOUT pin and the VSS pin. The current when the output pin is short-circuited (I_{SHORT}) is internally set at approx. 200 mA typ., and the normal value is restored for the output voltage, if releasing a short circuit once.

Caution This overcurrent protection circuit does not work as for thermal protection. If this IC long keeps short circuiting inside, pay attention to the conditions of input voltage and the load current so that, under the usage conditions including short circuit, the loss of the IC will not exceed power dissipation of the package.

5. Thermal shutdown circuit

The S-1155 Series has a thermal shutdown circuit to protect the device from damage due to overheat. When the junction temperature rises to 150°C typ., the thermal shutdown circuit operates to stop regulating. When the junction temperature drops to 120°C typ., the thermal shutdown circuit is released to restart regulating.

Due to self-heating of the S-1155 Series, if the thermal shutdown circuit starts operating, it stops regulating so that the output voltage drops. When regulation stops, the S-1155 Series does not itself generate heat so that the IC's temperature drops. When the temperature drops, the thermal shutdown circuit is released to restart regulating, thus the S-1155 Series generates heat again. Repeating this procedure makes waveform of the output voltage pulse-like form. Stop or restart of regulation continues unless decreasing either or both of the input voltage and the output current in order to reduce the internal power consumption, or decreasing the ambient temperature.

Table 7

Thermal Shutdown Circuit	VOUT Pin Voltage
Operation: 150°C typ.*1	V _{SS} level
Release: 120°C typ.*1	Set value

*1. Junction temperature

6. Inrush current limit circuit

The S-1155 Series has a built-in inrush current limit circuit to limit the inrush current generated at power-on or at the time when the ON/OFF pin is set to ON. This circuit limits the inrush current (400 mA, typ.) immediately after power-on or from the time when the ON/OFF pin is set to ON until the specified time (100 μs min.) which is set internally.

Caution The junction temperature drops to 120°C typ. by the operation of thermal shutdown circuit, after stopping regulation, the circuit is released to restart regulation; in this case, note that the period to limit inrush current may become shorter (10 μs min.).

■ Precautions

- Wiring patterns for the VIN pin, the VOUT pin and GND should be designed so that the impedance is low. When mounting an output capacitor between the VOUT pin and the VSS pin (C_L) and a capacitor for stabilizing the input between the VIN pin and the VSS pin (C_{IN}), the distance from the capacitors to these pins should be as short as possible.
- Note that generally the output voltage may increase when a series regulator is used at low load current (1.0 mA or less).
- Note that generally the output voltage may increase due to the leakage current from an output driver when a series regulator is used at high temperature.
- Note that the output voltage may increase due to the leakage current from an output driver even if the ON/OFF pin is at OFF level when a series regulator is used at high temperature.
- Generally a series regulator may cause oscillation, depending on the selection of external parts. The following conditions are recommended for the S-1155 Series. However, be sure to perform sufficient evaluation under the actual usage conditions for selection, including evaluation of temperature characteristics. Refer to “**5. Example of Equivalent Series Resistance vs. Output Current Characteristics ($T_a = 25^\circ\text{C}$)**” in “**■ Reference Data**” for the equivalent series resistance (R_{ESR}) of the output capacitor.

Input capacitor (C_{IN}): 4.7 μF or more

Output capacitor (C_L): 4.7 μF or more

- The voltage regulator may oscillate when the impedance of the power supply is high and the input capacitance is small or an input capacitor is not connected. Note that the voltage regulator may oscillate when the value of the output capacitor is greater than that of the input capacitor.
- Ringing may occur when these three conditions below are satisfied. Before selecting an input capacitor, be sure to evaluate sufficiently under the actual usage conditions, including the temperature characteristics.
 - The power supply inductance is high.
 - The load current is 100 mA or more.
 - The difference between the input voltage and the output voltage is close to the value of dropout voltage.
- If the output capacitance is small, power supply's fluctuation and the characteristics of load fluctuation become worse. Sufficiently evaluate the output voltage's fluctuation with the actual device.
- Overshoot may occur in the output voltage momentarily if the voltage is rapidly raised at power-on or when the power supply fluctuates. Sufficiently evaluate the output voltage at power-on with the actual device.
- The application conditions for the input voltage, the output voltage, and the load current should not exceed the package power dissipation.
- Do not apply an electrostatic discharge to this IC that exceeds the performance ratings of the built-in electrostatic protection circuit.
- In determining the output current, attention should be paid to the output current value specified in **Table 5** in “**■ Electrical Characteristics**” and footnote *5 of the table.
- SII Semiconductor Corporation claims no responsibility for any disputes arising out of or in connection with any infringement by products including this IC of patents owned by a third party.

■ Characteristics (Typical Data)

1. Output Voltage vs. Output Current (When load current increases) ($T_a = 25^\circ\text{C}$)

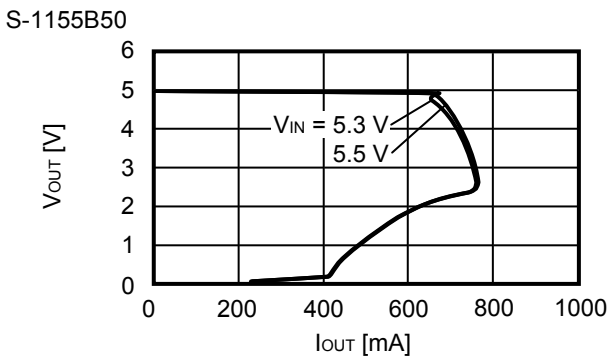
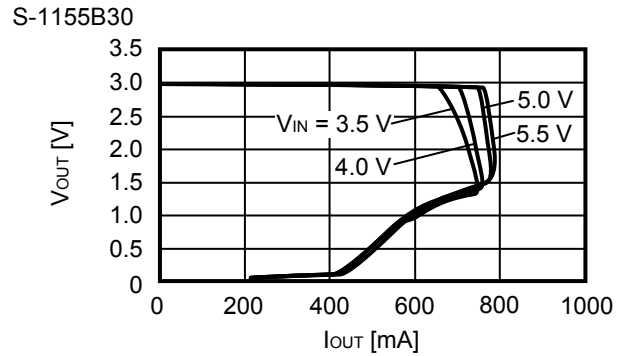
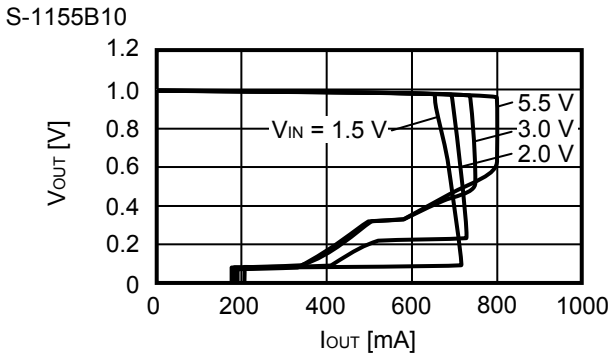

Remark In determining the output current, attention should be paid to the following.

1. The minimum output current value and footnote *5 of Table 5 in "■ Electrical Characteristics"
2. Power dissipation of the package

2. Output Voltage vs. Input Voltage ($T_a = 25^\circ\text{C}$)

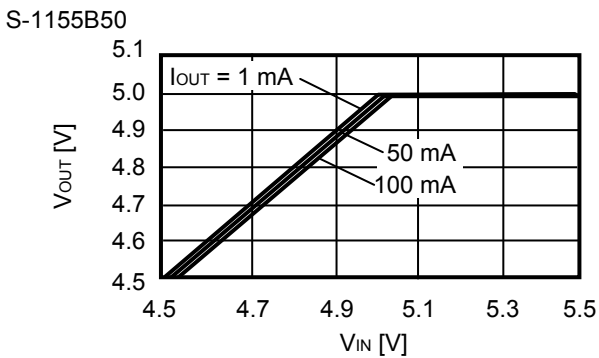
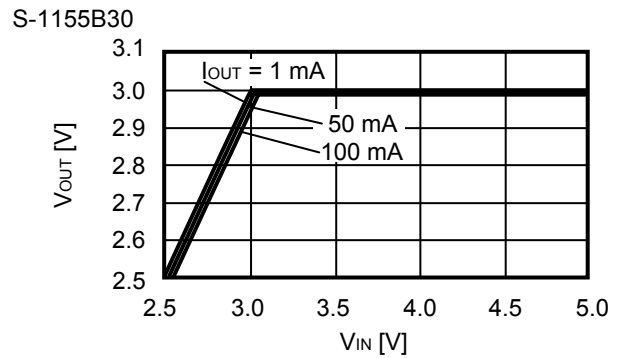
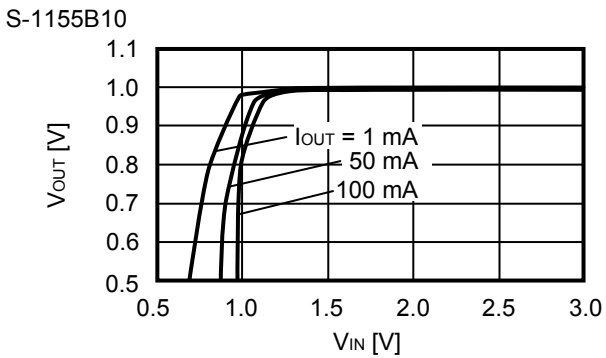

3. Dropout Voltage vs. Output Current

S-1155B10

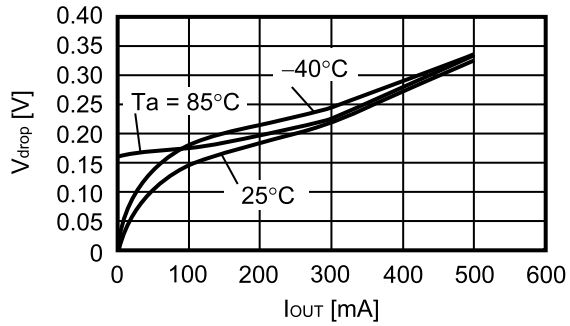

S-1155B30

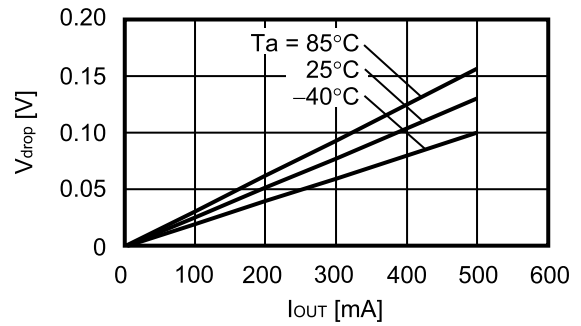

S-1155B50

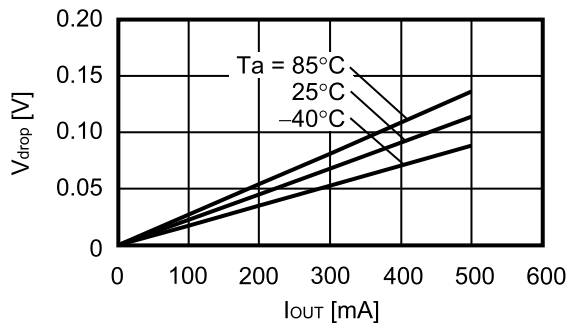

4. Dropout Voltage vs. Set Output Voltage

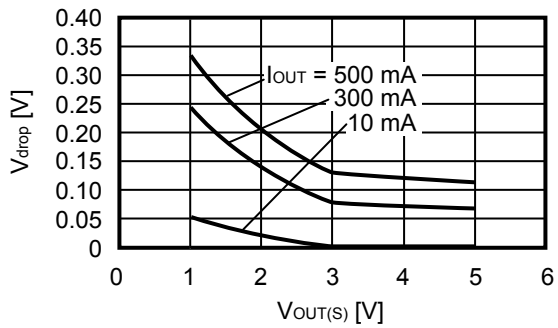

5. Output Voltage vs. Ambient Temperature

S-1155B10

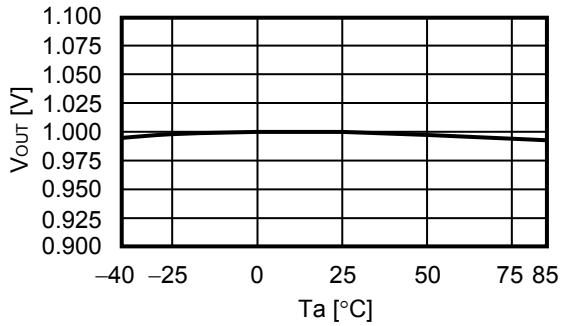

S-1155B30

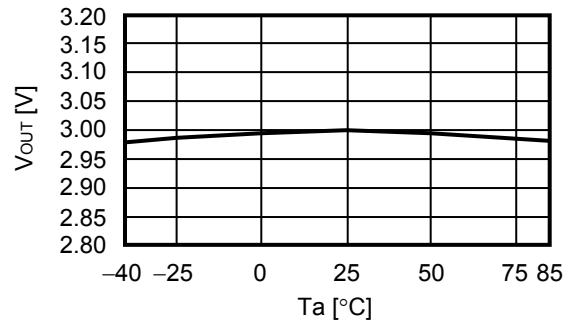

S-1155B50

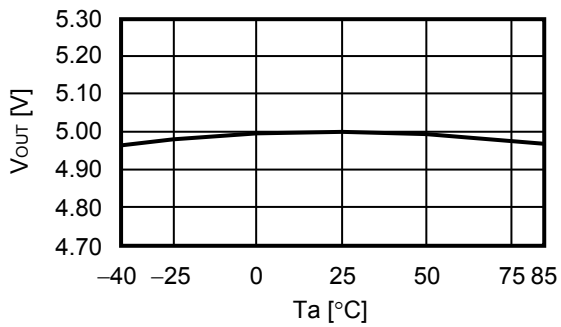

6. Current Consumption vs. Input Voltage

S-1155B10

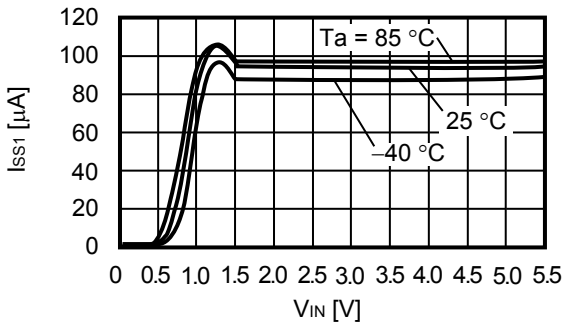

S-1155B30

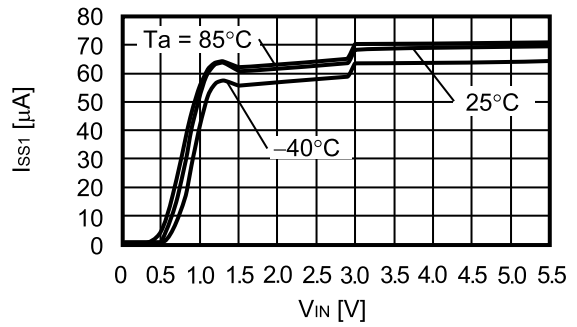

S-1155B50

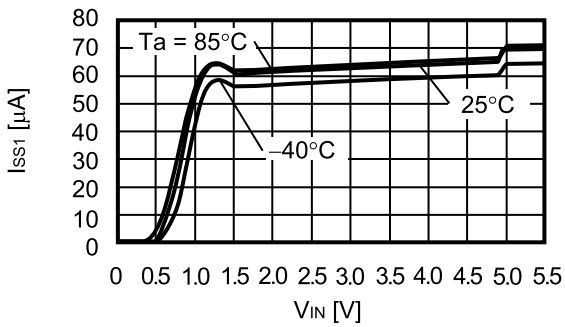

7. Ripple Rejection ($T_a = 25^\circ\text{C}$)

S-1155B10

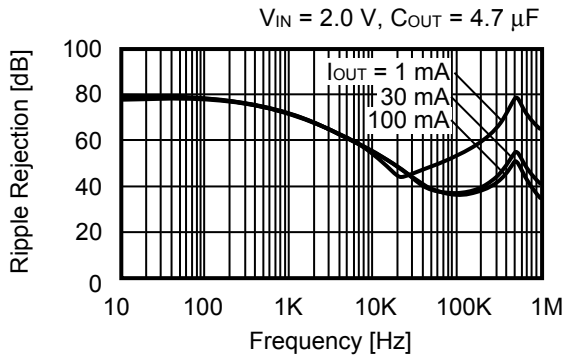

S-1155B30

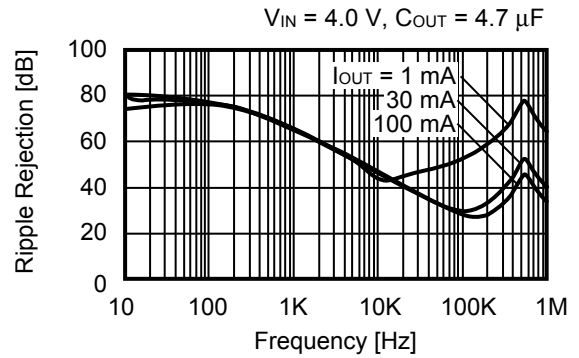

S-1155B50

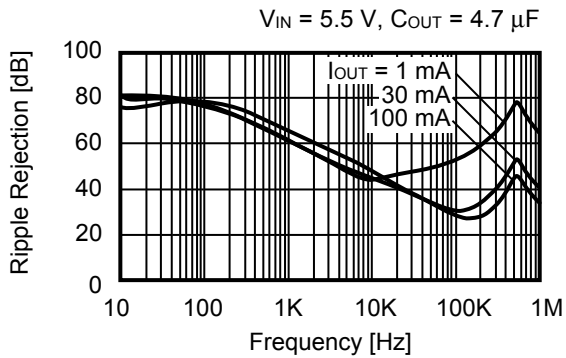

■ Reference Data

1. Characteristics of Input Transient Response (Ta = 25°C)

S-1155B10

$I_{OUT} = 100 \text{ mA}$, $t_r = t_f = 5.0 \text{ }\mu\text{s}$, $C_{OUT} = 4.7 \text{ }\mu\text{F}$, $C_{IN} = 4.7 \text{ }\mu\text{F}$

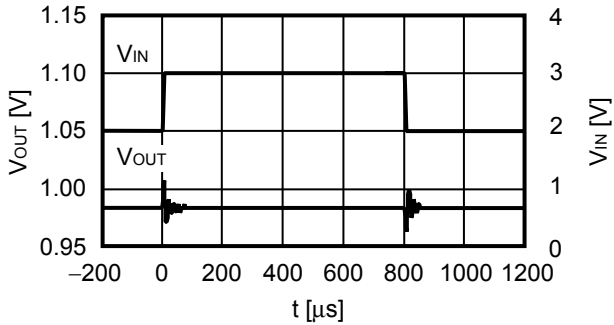

S-1155B30

$I_{OUT} = 100 \text{ mA}$, $t_r = t_f = 5.0 \text{ }\mu\text{s}$, $C_{OUT} = 4.7 \text{ }\mu\text{F}$, $C_{IN} = 4.7 \text{ }\mu\text{F}$

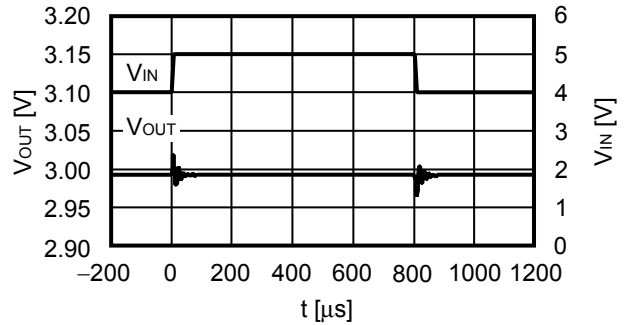

S-1155B50

$I_{OUT} = 100 \text{ mA}$, $t_r = t_f = 5.0 \text{ }\mu\text{s}$, $C_{OUT} = 4.7 \text{ }\mu\text{F}$, $C_{IN} = 4.7 \text{ }\mu\text{F}$

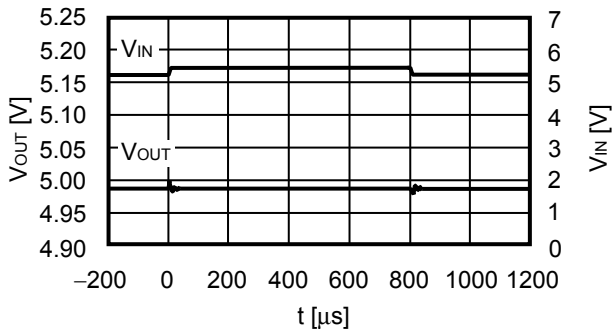

2. Characteristics of Load Transient Response (Ta = 25°C)

S-1155B10

$V_{IN} = 2.0 \text{ V}$, $C_{OUT} = 4.7 \text{ }\mu\text{F}$, $C_{IN} = 4.7 \text{ }\mu\text{F}$, $I_{OUT} = 50 \text{ mA} \leftrightarrow 100 \text{ mA}$

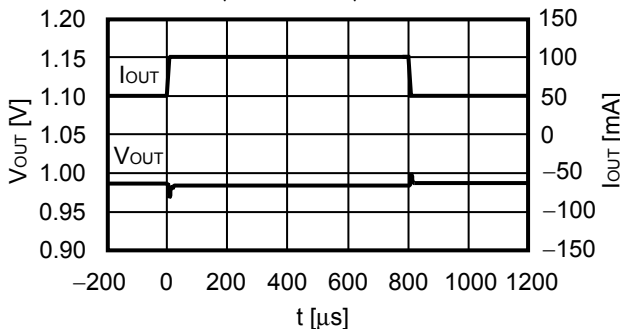

S-1155B30

$V_{IN} = 4.0 \text{ V}$, $C_{OUT} = 4.7 \text{ }\mu\text{F}$, $C_{IN} = 4.7 \text{ }\mu\text{F}$, $I_{OUT} = 50 \text{ mA} \leftrightarrow 100 \text{ mA}$

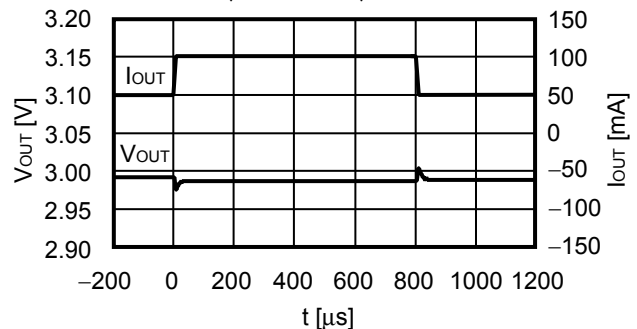

S-1155B50

$V_{IN} = 5.5 \text{ V}$, $C_{OUT} = 4.7 \text{ }\mu\text{F}$, $C_{IN} = 4.7 \text{ }\mu\text{F}$, $I_{OUT} = 50 \text{ mA} \leftrightarrow 100 \text{ mA}$

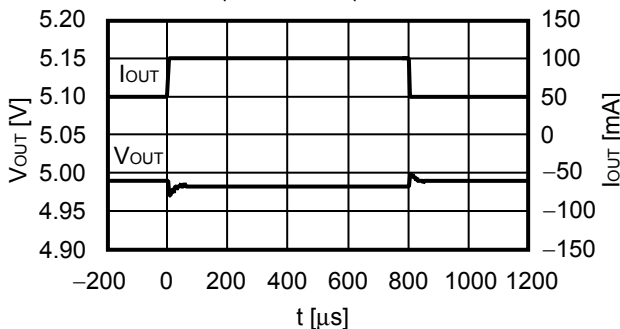

3. Transient Response Characteristics of ON/OFF Pin ($T_a = 25^\circ\text{C}$)

S-1155B10

$V_{IN} = 2.0\text{ V}$, $C_{OUT} = 4.7\ \mu\text{F}$, $C_{IN} = 4.7\ \mu\text{F}$, $I_{OUT} = 100\ \text{mA}$
 $V_{ON/OFF} = 0\ \text{V} \rightarrow 2.0\ \text{V}$, $t_r = 1.0\ \mu\text{s}$

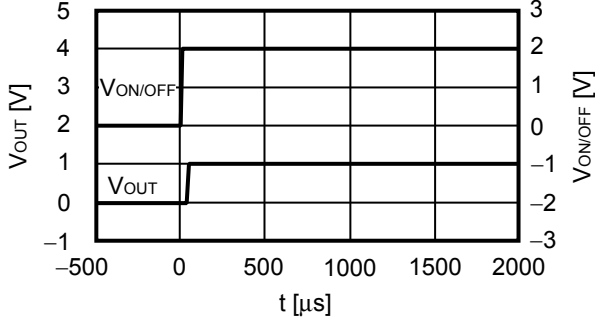

S-1155B30

$V_{IN} = 4.0\ \text{V}$, $C_{OUT} = 4.7\ \mu\text{F}$, $C_{IN} = 4.7\ \mu\text{F}$, $I_{OUT} = 100\ \text{mA}$
 $V_{ON/OFF} = 0\ \text{V} \rightarrow 4.0\ \text{V}$, $t_r = 1.0\ \mu\text{s}$

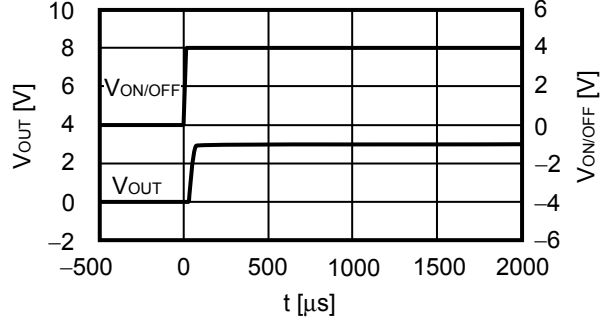

S-1155B50

$V_{IN} = 5.5\ \text{V}$, $C_{OUT} = 4.7\ \mu\text{F}$, $C_{IN} = 4.7\ \mu\text{F}$, $I_{OUT} = 100\ \text{mA}$
 $V_{ON/OFF} = 0\ \text{V} \rightarrow 5.5\ \text{V}$, $t_r = 1.0\ \mu\text{s}$

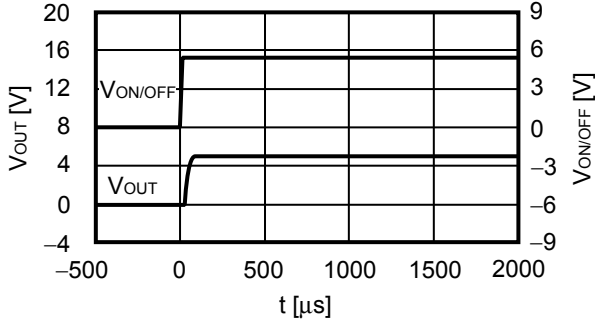

4. Characteristics of Inrush Current ($T_a = 25^\circ\text{C}$)

S-1155B10

$V_{IN} = 2.0\ \text{V}$, $C_{OUT} = 4.7\ \mu\text{F}$, $C_{IN} = 4.7\ \mu\text{F}$, $I_{OUT} = 100\ \text{mA}$

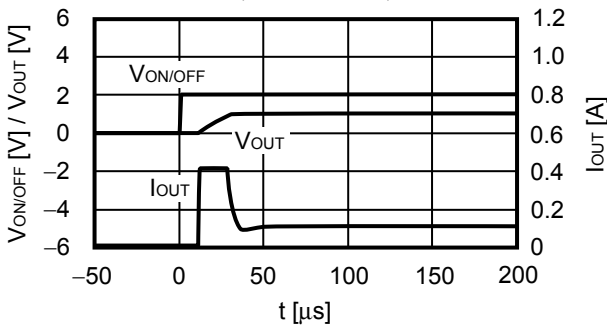

$V_{IN} = 2.0\ \text{V}$, $C_{OUT} = 4.7\ \mu\text{F}$, $C_{IN} = 4.7\ \mu\text{F}$, $I_{OUT} = 500\ \text{mA}$

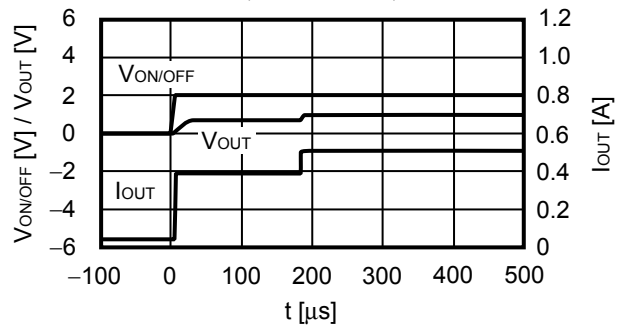

S-1155B30

$V_{IN} = 4.0\ \text{V}$, $C_{OUT} = 4.7\ \mu\text{F}$, $C_{IN} = 4.7\ \mu\text{F}$, $I_{OUT} = 100\ \text{mA}$

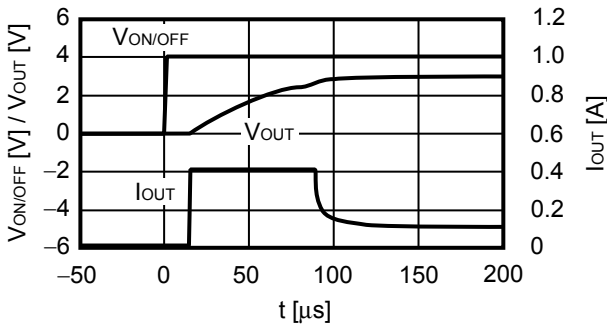

$V_{IN} = 4.0\ \text{V}$, $C_{OUT} = 4.7\ \mu\text{F}$, $C_{IN} = 4.7\ \mu\text{F}$, $I_{OUT} = 500\ \text{mA}$

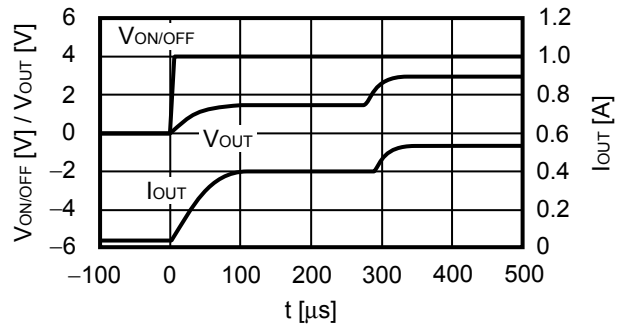

S-1155B50

$V_{IN} = 5.5\text{ V}$, $C_{OUT} = 4.7\ \mu\text{F}$, $C_{IN} = 4.7\ \mu\text{F}$, $I_{OUT} = 100\text{ mA}$

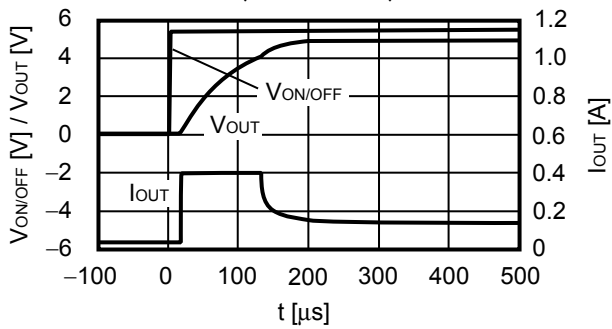

$V_{IN} = 5.5\text{ V}$, $C_{OUT} = 4.7\ \mu\text{F}$, $C_{IN} = 4.7\ \mu\text{F}$, $I_{OUT} = 500\text{ mA}$

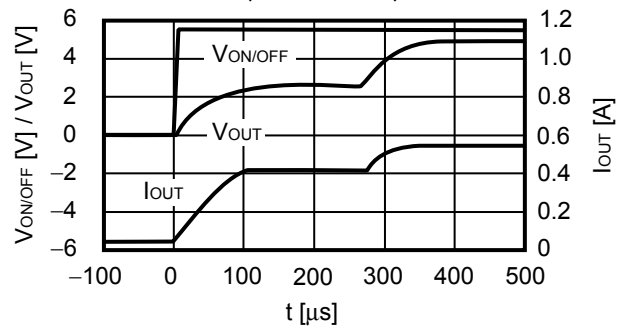

5. Example of Equivalent Series Resistance vs. Output Current Characteristics ($T_a = 25^\circ\text{C}$)

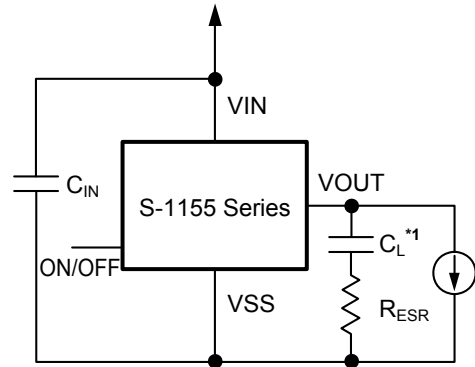
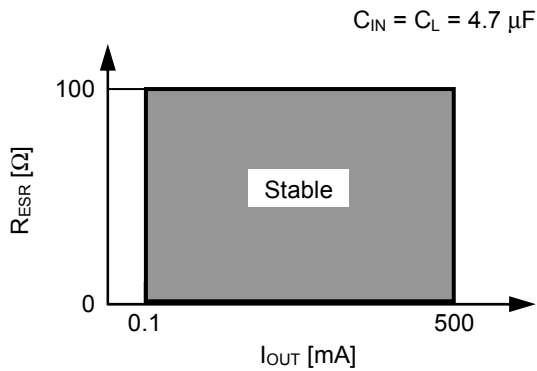

*1. C_L : TAIYO YUDEN Co., Ltd. LMK316BJ475ML (4.7 μF)

■ **Marking Specification**

1. **SOT-89-5**

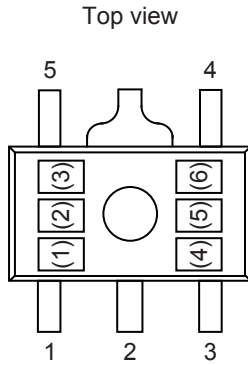

(1) to (3) : Product abbreviation (refer to **Product Name vs. Product Code**)
 (4) to (6) : Lot number

Product Name vs. Product Code

Product Name	Product Code		
	(1)	(2)	(3)
S-1155B10-U5T1x	S	K	A
S-1155B11-U5T1x	S	K	B
S-1155B12-U5T1x	S	K	C
S-1155B13-U5T1x	S	K	D
S-1155B14-U5T1x	S	K	E
S-1155B15-U5T1x	S	K	F
S-1155B16-U5T1x	S	K	G
S-1155B17-U5T1x	S	K	H
S-1155B18-U5T1x	S	K	I
S-1155B1J-U5T1x	S	K	J
S-1155B19-U5T1x	S	K	K
S-1155B20-U5T1x	S	K	L
S-1155B21-U5T1x	S	K	M
S-1155B22-U5T1x	S	K	N
S-1155B23-U5T1x	S	K	O
S-1155B24-U5T1x	S	K	P
S-1155B25-U5T1x	S	K	Q
S-1155B26-U5T1x	S	K	R
S-1155B27-U5T1x	S	K	S
S-1155B28-U5T1x	S	K	T
S-1155B2J-U5T1x	S	K	U
S-1155B29-U5T1x	S	K	V

Product Name	Product Code		
	(1)	(2)	(3)
S-1155B30-U5T1x	S	K	W
S-1155B31-U5T1x	S	K	X
S-1155B32-U5T1x	S	K	Y
S-1155B33-U5T1x	S	K	Z
S-1155B34-U5T1x	S	L	A
S-1155B35-U5T1x	S	L	B
S-1155B36-U5T1x	S	L	C
S-1155B37-U5T1x	S	L	D
S-1155B38-U5T1x	S	L	E
S-1155B39-U5T1x	S	L	F
S-1155B40-U5T1x	S	L	G
S-1155B41-U5T1x	S	L	H
S-1155B42-U5T1x	S	L	I
S-1155B43-U5T1x	S	L	J
S-1155B44-U5T1x	S	L	K
S-1155B45-U5T1x	S	L	L
S-1155B46-U5T1x	S	L	M
S-1155B47-U5T1x	S	L	N
S-1155B48-U5T1x	S	L	O
S-1155B49-U5T1x	S	L	P
S-1155B50-U5T1x	S	L	Q

Remark 1. x: G or U

2. Please select products of environmental code = U for Sn 100%, halogen-free products.

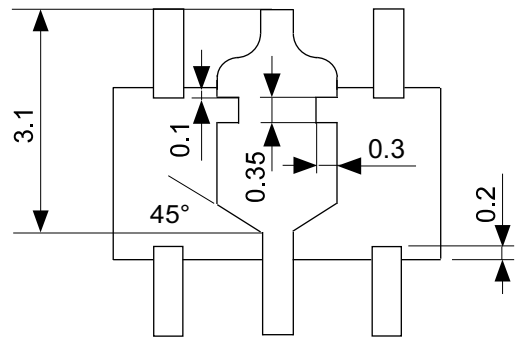
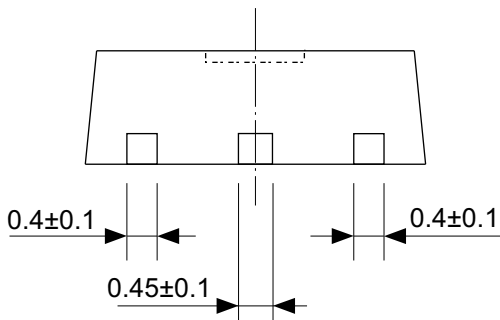
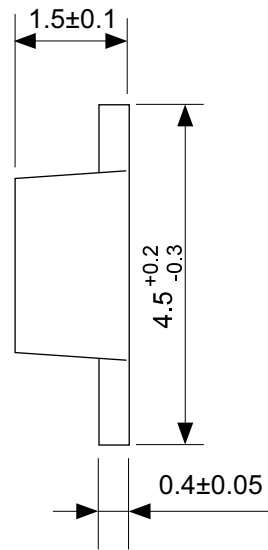
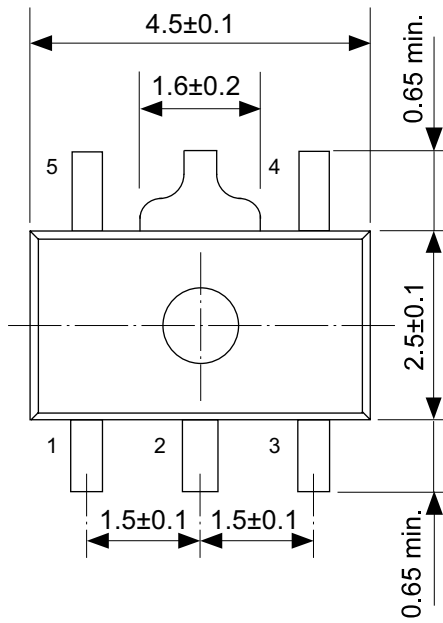

No. UP005-A-P-SD-1.1

TITLE	SOT895-A-PKG Dimensions
No.	UP005-A-P-SD-1.1
SCALE	
UNIT	mm
SII Semiconductor Corporation	

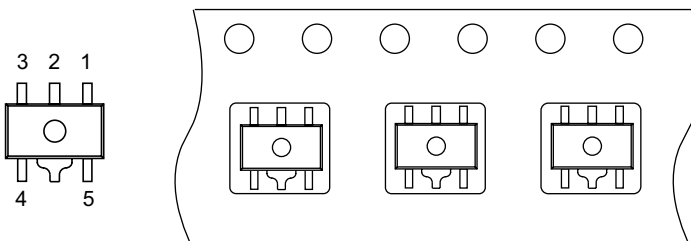
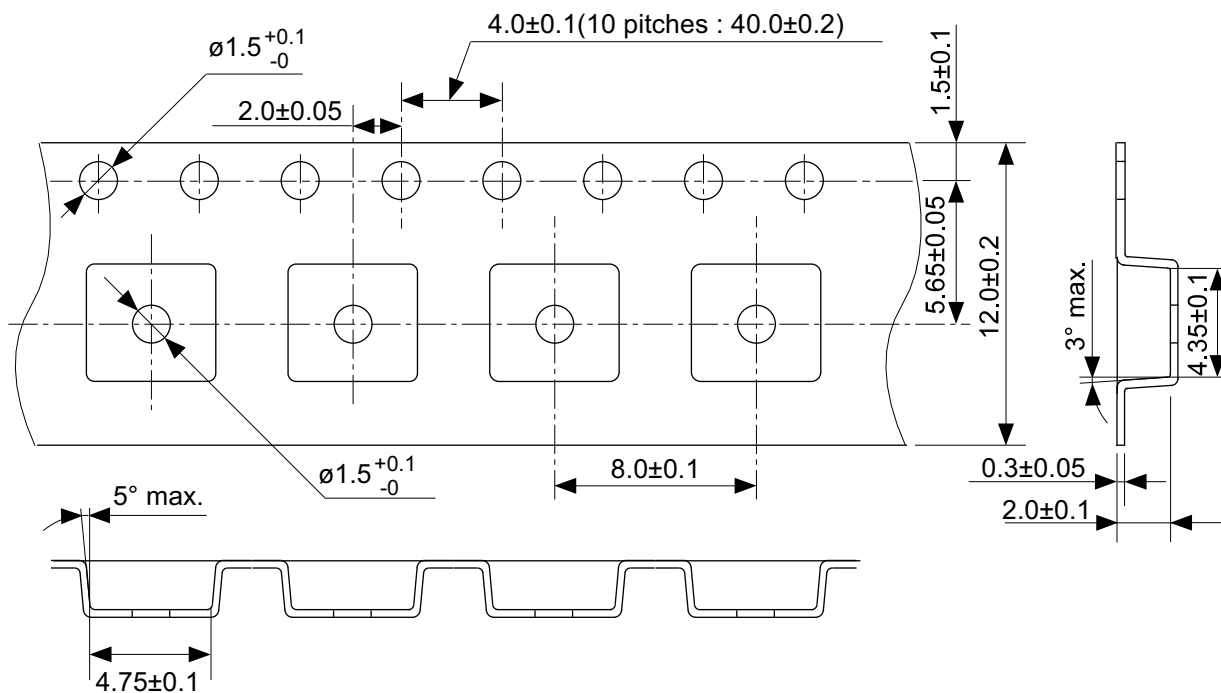

Feed direction

No. UP005-A-C-SD-1.1

TITLE	SOT895-A-Carrier Tape
No.	UP005-A-C-SD-1.1
SCALE	
UNIT	mm
SII Semiconductor Corporation	

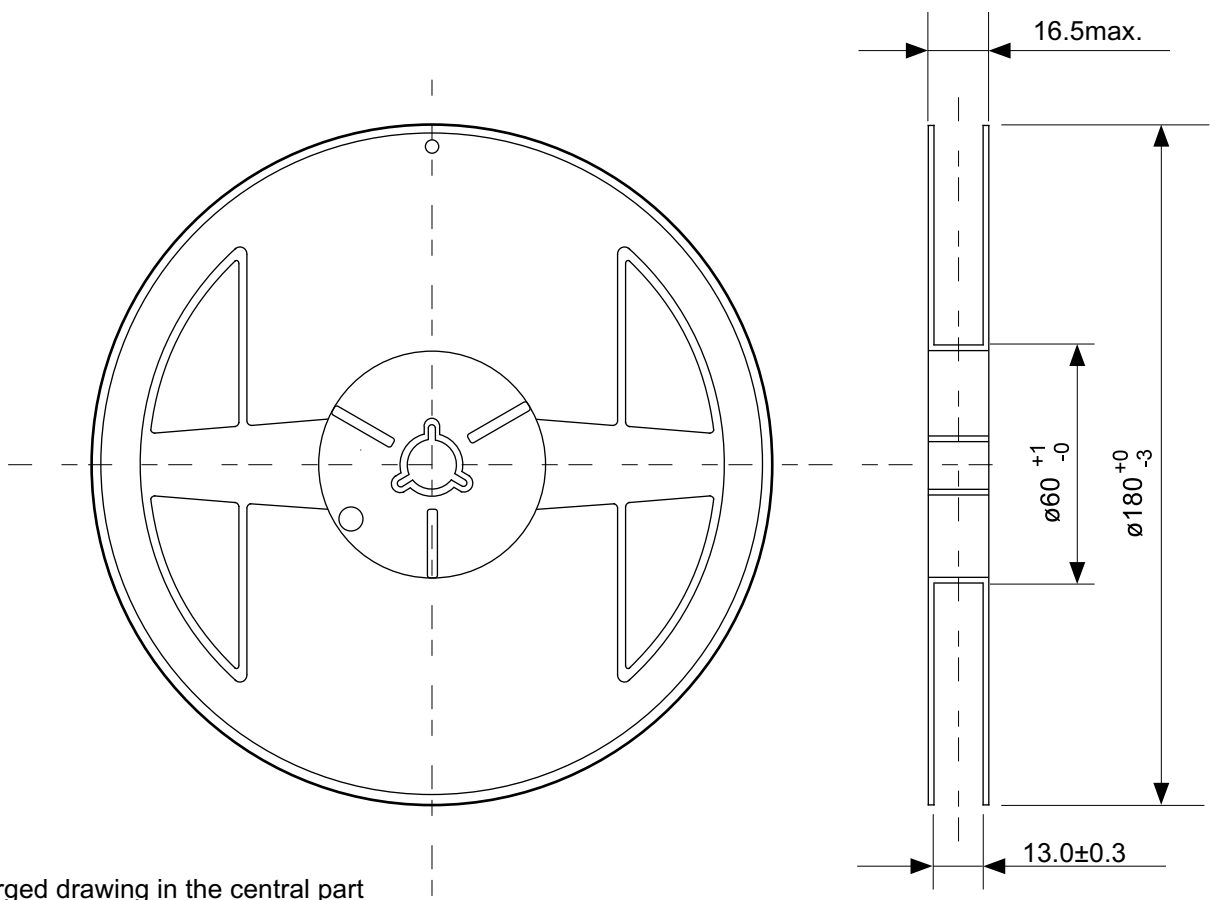

Enlarged drawing in the central part

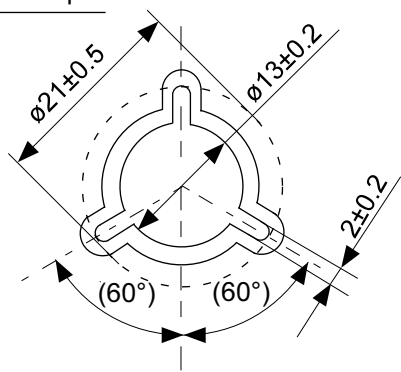

No. UP005-A-R-SD-1.1

TITLE	SOT895-A-Reel		
No.	UP005-A-R-SD-1.1		
SCALE		QTY.	1,000
UNIT	mm		
SII Semiconductor Corporation			

Disclaimers (Handling Precautions)

1. All the information described herein (product data, specifications, figures, tables, programs, algorithms and application circuit examples, etc.) is current as of publishing date of this document and is subject to change without notice.
2. The circuit examples and the usages described herein are for reference only, and do not guarantee the success of any specific mass-production design.
SII Semiconductor Corporation is not responsible for damages caused by the reasons other than the products or infringement of third-party intellectual property rights and any other rights due to the use of the information described herein.
3. SII Semiconductor Corporation is not responsible for damages caused by the incorrect information described herein.
4. Take care to use the products described herein within their specified ranges. Pay special attention to the absolute maximum ratings, operation voltage range and electrical characteristics, etc.
SII Semiconductor Corporation is not responsible for damages caused by failures and/or accidents, etc. that occur due to the use of products outside their specified ranges.
5. When using the products described herein, confirm their applications, and the laws and regulations of the region or country where they are used and verify suitability, safety and other factors for the intended use.
6. When exporting the products described herein, comply with the Foreign Exchange and Foreign Trade Act and all other export-related laws, and follow the required procedures.
7. The products described herein must not be used or provided (exported) for the purposes of the development of weapons of mass destruction or military use. SII Semiconductor Corporation is not responsible for any provision (export) to those whose purpose is to develop, manufacture, use or store nuclear, biological or chemical weapons, missiles, or other military use.
8. The products described herein are not designed to be used as part of any device or equipment that may affect the human body, human life, or assets (such as medical equipment, disaster prevention systems, security systems, combustion control systems, infrastructure control systems, vehicle equipment, traffic systems, in-vehicle equipment, aviation equipment, aerospace equipment, and nuclear-related equipment), excluding when specified for in-vehicle use or other uses. Do not use those products without the prior written permission of SII Semiconductor Corporation. Especially, the products described herein cannot be used for life support devices, devices implanted in the human body and devices that directly affect human life, etc.
Prior consultation with our sales office is required when considering the above uses.
SII Semiconductor Corporation is not responsible for damages caused by unauthorized or unspecified use of our products.
9. Semiconductor products may fail or malfunction with some probability.
The user of these products should therefore take responsibility to give thorough consideration to safety design including redundancy, fire spread prevention measures, and malfunction prevention to prevent accidents causing injury or death, fires and social damage, etc. that may ensue from the products' failure or malfunction.
The entire system must be sufficiently evaluated and applied on customer's own responsibility.
10. The products described herein are not designed to be radiation-proof. The necessary radiation measures should be taken in the product design by the customer depending on the intended use.
11. The products described herein do not affect human health under normal use. However, they contain chemical substances and heavy metals and should therefore not be put in the mouth. The fracture surfaces of wafers and chips may be sharp. Take care when handling these with the bare hands to prevent injuries, etc.
12. When disposing of the products described herein, comply with the laws and ordinances of the country or region where they are used.
13. The information described herein contains copyright information and know-how of SII Semiconductor Corporation.
The information described herein does not convey any license under any intellectual property rights or any other rights belonging to SII Semiconductor Corporation or a third party. Reproduction or copying of the information described herein for the purpose of disclosing it to a third-party without the express permission of SII Semiconductor Corporation is strictly prohibited.
14. For more details on the information described herein, contact our sales office.

1.0-2016.01

